



Asset Auctions SA
Terms & Conditions

- Asset Auctions SA sells all items on auction on behalf of the sellers.
- Asset Auctions SA is acting as an agent in the transaction between the sellers and buyers.
- **ALL ITEMS ARE SOLD AS "VOETSTOOTS"**
- **ANY DISCREPANCIES MUST BE DECLARED WITHIN 5 DAYS FROM AUCTION**
- Buyers Commission charged @ 5% + 15% VAT
- 3.5% will be charged additional on cash / card payments
- We kindly recommend EFT payments.
- Please ensure you have reviewed the Auction Terms & Conditions.
- **By placing a bid on the auction you are accepting the standard terms and conditions of the Auction.**
- All items to be collected by **Monday, 18 March 2024** by 5 o'clock.
- All payments must be made within **24 hours** of receipt of invoice.

Lot	M	F	T
Total	1	0	1

ADDITIONAL INFORMATION:

Lot Insurance: No
 Availability: In the Ring
 Delivery Date: Subject to payment
 Free Kilometers included in bidding price: 0
 Info 01:TERMS & CONDITIONS

Area: Vaalwater

African Wildlife Auctions

R

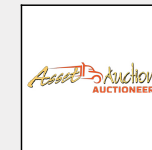



Lot	M	F	T
Total	1	0	1

ADDITIONAL INFORMATION:

Lot Insurance: No

Availability: In the Ring

Delivery Date: Subject to payment

Free Kilometers included in bidding price: 0

Info 01:VIKING MT785 RIDE ON LAWN

Info 02:MOWER WITH BACK LIFT, EXTRA

Info 03:BLADES AND INFO BOOK

Area: Vaalwater

Hendrik Van Heerden

R

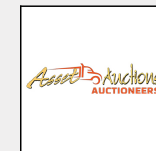



Lot	M	F	T
Total	1	0	1

ADDITIONAL INFORMATION:

Lot Insurance: No

Availability: In the Ring

Delivery Date: Subject to payment

Free Kilometers included in bidding price: 0

Info 01:ROBIN EY20 PROFESSIONAL

Info 02:ROLLER LAWN MOWER

Area: Vaalwater

Hendrik Van Heerden

R

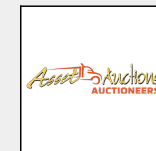



Lot	M	F	T
Total	1	0	1

ADDITIONAL INFORMATION:

Lot Insurance: No

Availability: In the Ring

Delivery Date: Subject to payment

Free Kilometers included in bidding price: 0

Info 01:LAWN MOWER SIDECUTTER

Info 02:4 STROKE WARRIOR

Area: Vaalwater

Hendrik Van Heerden

R

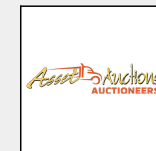



Lot	M	F	T
Total	1	0	1

ADDITIONAL INFORMATION:

Lot Insurance: No
 Availability: In the Ring
 Delivery Date: Subject to payment
 Free Kilometers included in bidding price: 0
 Info 01:TIPPER TRAILER - NO PAPERS

Area: Vaalwater

Ian van der Merwe

R

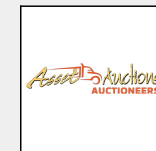



Lot	M	F	T
Total	1	0	1

ADDITIONAL INFORMATION:

Lot Insurance: No

Availability: In the Ring

Delivery Date: Subject to payment

Free Kilometers included in bidding price: 0

Info 01:JOHN DEERE TRACTOR, 1999

Info 02:YEAR MODEL, 12 000 HOURS -

Info 03:NO PAPERS

Area: Vaalwater

Ian van der Merwe

R

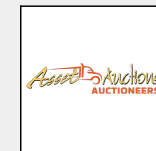



Lot	M	F	T
Total	1	0	1

ADDITIONAL INFORMATION:

Lot Insurance: No

Availability: In the Ring

Delivery Date: Subject to payment

Free Kilometers included in bidding price: 0

Info 01:VOLVO BL61 TLB, 2008 YEAR

Info 02:MODEL, 9 800 HOURS, PAPERS

Info 03:& LICENSE

Area: Vaalwater

Andre Meyer

R

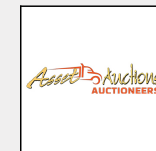



Lot	M	F	T
Total	1	0	1

ADDITIONAL INFORMATION:

Lot Insurance: No
 Availability: In the Ring
 Delivery Date: Subject to payment
 Free Kilometers included in bidding price: 0
 Info 01:LANDINI TRACTOR
 Info 02:LANDPOWER 130, 2007
 Info 03:MODEL 6500 HOURS - ROOF
 Info 04:DAMAGED - ROOF WILL BE
 Info 05:REPLACED ON PURCHASE
 Info 06:ON SALE

Area: Vaalwater

Gird Capital

R

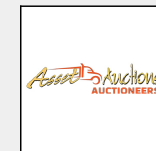



Lot	M	F	T
Total	1	0	1

ADDITIONAL INFORMATION:

Lot Insurance: No
 Availability: In the Ring
 Delivery Date: Subject to payment
 Free Kilometers included in bidding price: 0
 Info 01:SCRAPPER/DAM SCOOP

Area: Vaalwater

Thupa Seegers

R

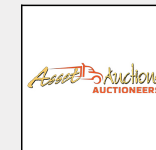



Lot	M	F	T
Total	1	0	1

ADDITIONAL INFORMATION:

Lot Insurance: No
 Availability: In the Ring
 Delivery Date: Subject to payment
 Free Kilometers included in bidding price: 0
 Info 01:GREEN TIPPING TRAILER
 Info 02:WITH LOW SIDES

Area: Vaalwater

Thupa Seegers

R

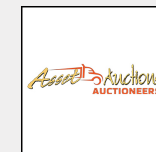



Lot	M	F	T
Total	1	0	1

ADDITIONAL INFORMATION:

Lot Insurance: No
 Availability: In the Ring
 Delivery Date: Subject to payment
 Free Kilometers included in bidding price: 0
 Info 01:2015 LINSSANA A/S TP 200
 Info 02:PTO WOODCHIPPER,
 Info 03:IN NEW CONDITION

Area: Vaalwater

Thupa Seegers

R





Lot	M	F	T
Total	1	0	1

ADDITIONAL INFORMATION:

Lot Insurance: No

Availability: In the Ring

Delivery Date: Subject to payment

Free Kilometers included in bidding price: 0

Info 01:GREEN TRAILER WITH HIGH SIDES

Area: Vaalwater

Thupa Seegers

R





Lot	M	F	T
Total	1	0	1

ADDITIONAL INFORMATION:

Lot Insurance: No
 Availability: In the Ring
 Delivery Date: Subject to payment
 Free Kilometers included in bidding price: 0
 Info 01:LANDINI 125 TDL TRACTOR
 Info 02:NEEDS NEW BRAKES, NO PAPERS,
 Info 03:NO HR OR YEAR MODEL
 Info 04:WORKING CONDITION

Area: Vaalwater

Thupa Seegers

R

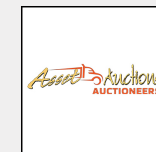



Lot	M	F	T
Total	1	0	1

ADDITIONAL INFORMATION:

Lot Insurance: No
 Availability: In the Ring
 Delivery Date: Subject to payment
 Free Kilometers included in bidding price: 0
 Info 01:TRUCK / GAME VIEWER SEATS
 Info 02:LWB 3 ROW

Area: Vaalwater

Thupa Seegers

R





Lot	M	F	T
Total	1	0	1

ADDITIONAL INFORMATION:

Lot Insurance: No
 Availability: In the Ring
 Delivery Date: Subject to payment
 Free Kilometers included in bidding price: 0
 Info 01:WHITE FLATBED TRAILER

Area: Vaalwater

Thupa Seegers

R

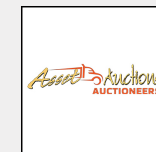



Lot	M	F	T
Total	1	0	1

ADDITIONAL INFORMATION:

Lot Insurance: No
 Availability: In the Ring
 Delivery Date: Subject to payment
 Free Kilometers included in bidding price: 0
 Info 01:1 x ROLLBAR & 1 x NUDGEBAR

Area: Vaalwater

Thupa Seegers

R





Lot	M	F	T
Total	1	0	1

ADDITIONAL INFORMATION:

Lot Insurance: No
 Availability: In the Ring
 Delivery Date: Subject to payment
 Free Kilometers included in bidding price: 0
 Info 01:CHROME ROLLBAR

Area: Vaalwater

Thupa Seegers

R

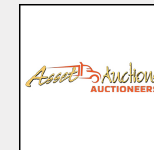



Lot	M	F	T
Total	1	0	1

ADDITIONAL INFORMATION:

Lot Insurance: No
 Availability: In the Ring
 Delivery Date: Subject to payment
 Free Kilometers included in bidding price: 0
 Info 01: MULTI PURPOSE FLATBED TRAILER

Area: Vaalwater

Thupa Seegers

R

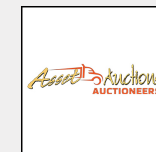



Lot	M	F	T
Total	1	0	1

ADDITIONAL INFORMATION:

Lot Insurance: No
 Availability: In the Ring
 Delivery Date: Subject to payment
 Free Kilometers included in bidding price: 0
 Info 01:PICK UP FIREFIGHTER -
 Info 02:NOT TESTED

Area: Vaalwater

Thupa Seegers

R

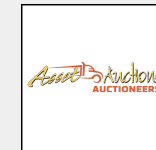



Lot	M	F	T
Total	1	0	1

ADDITIONAL INFORMATION:

Lot Insurance: No
 Availability: In the Ring
 Delivery Date: Subject to payment
 Free Kilometers included in bidding price: 0
 Info 01:FIREFIGHTER ON TRAILER -
 Info 02:NOT TESTED

Area: Vaalwater

Thupa Seegers

R

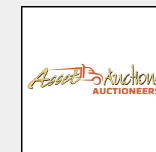



Lot	M	F	T
Total	1	0	1

ADDITIONAL INFORMATION:

Lot Insurance: No
 Availability: In the Ring
 Delivery Date: Subject to payment
 Free Kilometers included in bidding price: 0
 Info 01:RED TRAILER

Area: Vaalwater

Thupa Seegers

R

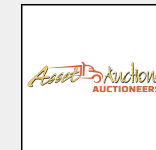



Lot	M	F	T
Total	1	0	1

ADDITIONAL INFORMATION:

Lot Insurance: No
 Availability: In the Ring
 Delivery Date: Subject to payment
 Free Kilometers included in bidding price: 0
 Info 01:HAMMERMILL
 Info 02:IN WORKING CONDITION

Area: Vaalwater

John Wageinhouse

R

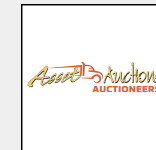



Lot	M	F	T
Total	1	0	1

ADDITIONAL INFORMATION:

Lot Insurance: No
 Availability: In the Ring
 Delivery Date: Subject to payment
 Free Kilometers included in bidding price: 0
 Info 01:DIESEL GENERATOR: 3 CYLINDER
 Info 02:LISTER ENGINE 8kva,
 Info 03:3 PHASE HOFFBERG ALTERNATOR,
 Info 04:ELECTRIC START WITHOUT
 Info 05:BATTERIES ON ARMY TRAILER
 Info 06:IN WORKING CONDITION

Area: Vaalwater

Leon Skinner

R

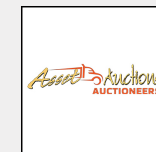



Lot	M	F	T
Total	1	0	1

ADDITIONAL INFORMATION:

Lot Insurance: No
 Availability: In the Ring
 Delivery Date: Subject to payment
 Free Kilometers included in bidding price: 0
 Info 01:RUBBERDUCK WITH 115 YAMAHA
 Info 02:ENGINE, 2T AUTO LUBE,
 Info 03:TRAILER HAS PAPERS,
 Info 04:ROADWORTHY TO BE DONE WITHIN
 Info 05:30 DAYS WILL BE ARRANGED
 Info 06:BY CURRENT OWNER
 Info 07:NO BOYENCY CERTIFICATE
 Info 08:AVAILABLE

Area: Vaalwater

Yolandy Sieberts

R





Lot	M	F	T
Total	2	0	2

ADDITIONAL INFORMATION:

Lot Insurance: No
 Availability: In the Ring
 Delivery Date: Subject to payment
 Free Kilometers included in bidding price: 0
 Info 01:TROGTEK TROUGHS
 Info 02:2000 x 700 x 500cm

Area: Vaalwater

Roney Mitchell

R

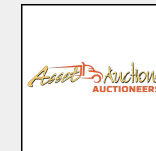



Lot	M	F	T
Total	2	0	2

ADDITIONAL INFORMATION:

Lot Insurance: No
 Availability: In the Ring
 Delivery Date: Subject to payment
 Free Kilometers included in bidding price: 0
 Info 01:TROGTEK TROUGHES
 Info 02:3500 x 300 x 400cm

Area: Vaalwater

Roney Mitchell

R

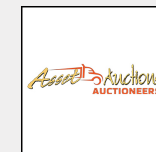



Lot	M	F	T
Total	2	0	2

ADDITIONAL INFORMATION:

Lot Insurance: No
 Availability: In the Ring
 Delivery Date: Subject to payment
 Free Kilometers included in bidding price: 0
 Info 01:TROGTEK TROUGHES
 Info 02:3500 x 700 x 500cm

Area: Vaalwater

Roney Mitchell

R

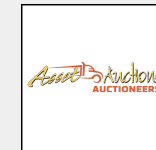



Lot	M	F	T
Total	2	0	2

ADDITIONAL INFORMATION:

Lot Insurance: No
 Availability: In the Ring
 Delivery Date: Subject to payment
 Free Kilometers included in bidding price: 0
 Info 01:TROGTEK TROUGHES
 Info 02:3500 x 700 x 500cm

Area: Vaalwater

Roney Mitchell

R

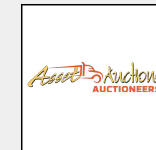



Lot	M	F	T
Total	1	0	1

ADDITIONAL INFORMATION:

Lot Insurance: No
 Availability: In the Ring
 Delivery Date: Subject to payment
 Free Kilometers included in bidding price: 0
 Info 01:OVAL TROGTEK TROUGH

Area: Vaalwater

Roney Mitchell

R

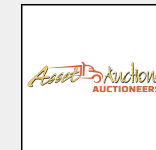



Lot	M	F	T
Total	3	0	3

ADDITIONAL INFORMATION:

Lot Insurance: No
 Availability: In the Ring
 Delivery Date: Subject to payment
 Free Kilometers included in bidding price: 0
 Info 01:JOJO TROUGHS 1200 x 800cm

Area: Vaalwater

Roney Mitchell

R

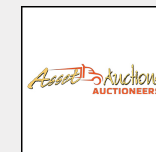



Lot	M	F	T
Total	2	0	2

ADDITIONAL INFORMATION:

Lot Insurance: No
 Availability: In the Ring
 Delivery Date: Subject to payment
 Free Kilometers included in bidding price: 0
 Info 01:JOJO TROUGHS 1200 x 800cm

Area: Vaalwater

Roney Mitchell

R

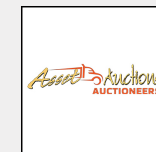



Lot	M	F	T
Total	3	0	3

ADDITIONAL INFORMATION:

Lot Insurance: No
 Availability: In the Ring
 Delivery Date: Subject to payment
 Free Kilometers included in bidding price: 0
 Info 01:GATES 2.5 x 4 / 4.2m

Area: Vaalwater

Roney Mitchell

R

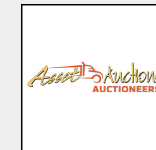



Lot	M	F	T
Total	5	0	5

ADDITIONAL INFORMATION:

Lot Insurance: No
 Availability: In the Ring
 Delivery Date: Subject to payment
 Free Kilometers included in bidding price: 0
 Info 01:GATES 2.4 x 4 / 4.2m

Area: Vaalwater

Roney Mitchell

R

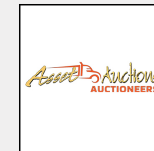



Lot	M	F	T
Total	5	0	5

ADDITIONAL INFORMATION:

Lot Insurance: No
 Availability: In the Ring
 Delivery Date: Subject to payment
 Free Kilometers included in bidding price: 0
 Info 01:GATES 2.4 x 4 / 4.2m

Area: Vaalwater

Roney Mitchell

R

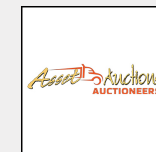



Lot	M	F	T
Total	5	0	5

ADDITIONAL INFORMATION:

Lot Insurance: No
 Availability: In the Ring
 Delivery Date: Subject to payment
 Free Kilometers included in bidding price: 0
 Info 01:GATES 2.4 x 4 / 4.2m

Area: Vaalwater

Roney Mitchell

R

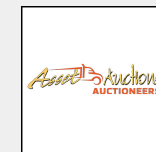



Lot	M	F	T
Total	5	0	5

ADDITIONAL INFORMATION:

Lot Insurance: No
 Availability: In the Ring
 Delivery Date: Subject to payment
 Free Kilometers included in bidding price: 0
 Info 01:GATES 2.4 x 4 / 4.2m

Area: Vaalwater

Roney Mitchell

R

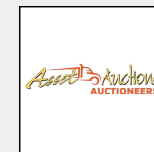



Lot	M	F	T
Total	5	0	5

ADDITIONAL INFORMATION:

Lot Insurance: No

Availability: In the Ring

Delivery Date: Subject to payment

Free Kilometers included in bidding price: 0

Info 01:GATES VARIOUS SIZES

Area: Vaalwater

Roney Mitchell

R

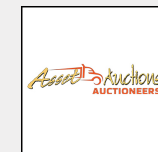



Lot	M	F	T
Total	5	0	5

ADDITIONAL INFORMATION:

Lot Insurance: No
 Availability: In the Ring
 Delivery Date: Subject to payment
 Free Kilometers included in bidding price: 0
 Info 01:FUN GALVANIZED JACKAL
 Info 02:FENCE 1800cm x 50 x 75mm

Area: Vaalwater

Roney Mitchell

R

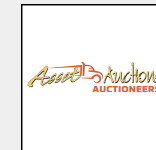



Lot	M	F	T
Total	5	0	5

ADDITIONAL INFORMATION:

Lot Insurance: No
 Availability: In the Ring
 Delivery Date: Subject to payment
 Free Kilometers included in bidding price: 0
 Info 01:FUN GALVANIZED JACKALS
 Info 02:FENCE 1800cm x 50 x 75mm

Area: Vaalwater

Roney Mitchell

R

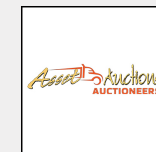



Lot	M	F	T
Total	6	0	6

ADDITIONAL INFORMATION:

Lot Insurance: No
 Availability: In the Ring
 Delivery Date: Subject to payment
 Free Kilometers included in bidding price: 0
 Info 01:FUN GALVANIZED JACKALS
 Info 02:FENCE 1800cm x 50 x 75mm

Area: Vaalwater

Roney Mitchell

R

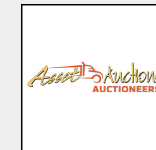



Lot	M	F	T
Total	1	0	1

ADDITIONAL INFORMATION:

Lot Insurance: No
 Availability: In the Ring
 Delivery Date: Subject to payment
 Free Kilometers included in bidding price: 0
 Info 01:1 TINE RIPPER

Area: Vaalwater

Pieter Rautenbach

R

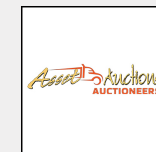



Lot	M	F	T
Total	1	0	1

ADDITIONAL INFORMATION:

Lot Insurance: No
 Availability: In the Ring
 Delivery Date: Subject to payment
 Free Kilometers included in bidding price: 0
 Info 01:TIPPING TRAILER

Area: Vaalwater

Pieter Rautenbach

R

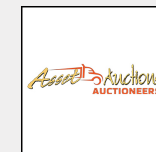



Lot	M	F	T
Total	1	0	1

ADDITIONAL INFORMATION:

Lot Insurance: No
 Availability: In the Ring
 Delivery Date: Subject to payment
 Free Kilometers included in bidding price: 0
 Info 01:WATER TANK - 2500L

Area: Vaalwater

Pieter Rautenbach

R

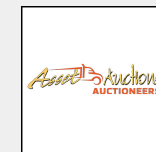

Lot 016-C01 (Per Unit) Farm Implements - Farm



Lot	M	F	T
Total	1	0	1

ADDITIONAL INFORMATION:

Lot Insurance: No

Delivery Date: Subject to payment

Free Kilometers included in bidding price: 0

Info 01:2 FURROW PLOUGH - TO BE

Info 02:COLLECTED AT

Info 03:MOOKGOPHONG

Area: Mookgophong

Jaco Van Heerden

R

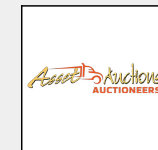

Lot 016-C02 (Per Unit) Farm Implements - Farm



Lot	M	F	T
Total	1	0	1

ADDITIONAL INFORMATION:

Lot Insurance: No
 Availability: On Catalogue
 Delivery Date: Subject to payment
 Free Kilometers included in bidding price: 0
 Info 01:RED 3 DISC PLOUGH - TO
 Info 02:BE COLLECTED AT
 Info 03:MOOKGOPHONG

Area: Mookgophong

Jaco Van Heerden

R

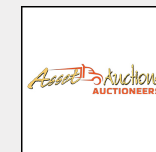



Lot	M	F	T
Total	1	0	1

ADDITIONAL INFORMATION:

Lot Insurance: No
 Availability: On Catalogue
 Delivery Date: Subject to payment
 Free Kilometers included in bidding price: 0
 Info 01:HAMMERMILL PTO - TO BE
 Info 02:COLLECTED AT
 Info 03:MOOKGOPHONG

Area: Mookgophong

Jaco Van Heerden

R

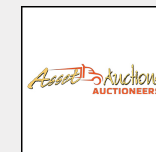



Lot	M	F	T
Total	1	0	1

ADDITIONAL INFORMATION:

Lot Insurance: No
 Availability: In the Ring
 Delivery Date: Subject to payment
 Free Kilometers included in bidding price: 0
 Info 01:HYDRAULIC TIPPING TRAILER
 Info 02:TO BE COLLECTED AT
 Info 03:MOOKGOPHONG

Area: Mookgophong

Jaco Van Heerden

R

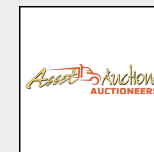

Lot 016-C05 (Per Unit) Farm Implements - Farm



Lot	M	F	T
Total	1	0	1

ADDITIONAL INFORMATION:

Lot Insurance: No
 Availability: On Catalogue
 Delivery Date: Subject to payment
 Free Kilometers included in bidding price: 0
 Info 01:3 RIDGER PLOUGH - TO BE
 Info 02:COLLECTED AT
 Info 03:MOOKGOPHONG

Area: Mookgophong

Jaco Van Heerden

R

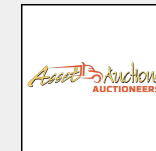



Lot	M	F	T
Total	1	0	1

ADDITIONAL INFORMATION:

Lot Insurance: No
 Availability: In the Ring
 Delivery Date: Subject to payment
 Free Kilometers included in bidding price: 0
 Info 01:BIG BOY JNR 90, 4 STROKE
 Info 02:NEEDS NEW BATTERY

Area: Vaalwater

Zadia Lubbe

R

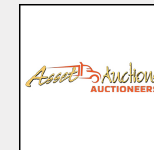



Lot	M	F	T
Total	1	0	1

ADDITIONAL INFORMATION:

Lot Insurance: No

Availability: In the Ring

Delivery Date: Subject to payment

Free Kilometers included in bidding price: 0

Info 01:AVALANCHE COSMIC 24 BICYCLE

Area: Vaalwater

Zadia Lubbe

R





Lot	M	F	T
Total	1	0	1

ADDITIONAL INFORMATION:

Lot Insurance: No

Availability: In the Ring

Delivery Date: Subject to payment

Free Kilometers included in bidding price: 0

Info 01:TITAN CALYPRO 24 BICYCLE

Area: Vaalwater

Zadia Lubbe

R

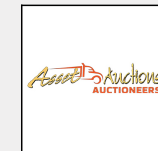



Lot	M	F	T
Total	1	0	1

ADDITIONAL INFORMATION:

Lot Insurance: No
 Availability: In the Ring
 Delivery Date: Subject to payment
 Free Kilometers included in bidding price: 0
 Info 01:GREGORIAN ORAL - NOT WORKING

Area: Vaalwater

Sollie Potgieter

R

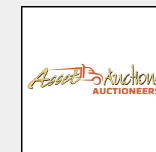



Lot	M	F	T
Total	1	0	1

ADDITIONAL INFORMATION:

Lot Insurance: No

Availability: In the Ring

Delivery Date: Subject to payment

Free Kilometers included in bidding price: 0

Info 01: MOZART PIANO - DAMAGED &

Info 02: KEYS MISSING

Area: Vaalwater

Sollie Potgieter

R

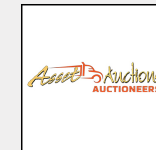



Lot	M	F	T
Total	2	0	2

ADDITIONAL INFORMATION:

Lot Insurance: No
 Availability: In the Ring
 Delivery Date: Subject to payment
 Free Kilometers included in bidding price: 0
 Info 01:BEDSIDE CABINETS

Area: Vaalwater

Zadia Lubbe

R





Lot	M	F	T
Total	1	0	1

ADDITIONAL INFORMATION:

Lot Insurance: No

Availability: In the Ring

Delivery Date: Subject to payment

Free Kilometers included in bidding price: 0

Info 01:OFFICE DESK - DRAWERS DAMAGED

Area: Vaalwater

Zadia Lubbe

R

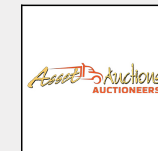



Lot	M	F	T
Total	1	0	1

ADDITIONAL INFORMATION:

Lot Insurance: No
 Availability: In the Ring
 Delivery Date: Subject to payment
 Free Kilometers included in bidding price: 0
 Info 01:EASY AWNING 2400
 Info 02:WIDTH 2300
 Info 03:ROLL OUT 1900
 Info 04:HEIGHT 2000

Area: Vaalwater

Hendrik Van Heerden

R





Lot	M	F	T
Total	1	0	1

ADDITIONAL INFORMATION:

Lot Insurance: No

Availability: In the Ring

Delivery Date: Subject to payment

Free Kilometers included in bidding price: 0

Info 01:DOUBLE JERRY CAN & GAS BOTTLE

Info 02:ROOF RACK HOLDER

Area: Vaalwater

Hendrik Van Heerden

R

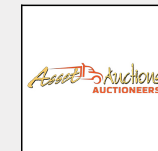



Lot	M	F	T
Total	1	0	1

ADDITIONAL INFORMATION:

Lot Insurance: No
 Availability: In the Ring
 Delivery Date: Subject to payment
 Free Kilometers included in bidding price: 0
 Info 01:WATER TANK 67L
 Info 02:L950 X W300 X H260

Area: Vaalwater

Hendrik Van Heerden

R





Lot	M	F	T
Total	1	0	1

ADDITIONAL INFORMATION:

Lot Insurance: No

Availability: In the Ring

Delivery Date: Subject to payment

Free Kilometers included in bidding price: 0

Info 01:1 x CAMPING SHOWER TENT &

Info 02:1 x TOILET TENT

Area: Vaalwater

Hendrik Van Heerden

R

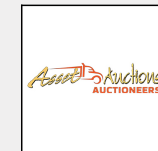



Lot	M	F	T
Total	1	0	1

ADDITIONAL INFORMATION:

Lot Insurance: No
 Availability: In the Ring
 Delivery Date: Subject to payment
 Free Kilometers included in bidding price: 0
 Info 01:2 PLATE GAS STOVE WITH BAG
 Info 02:LIKE NEW

Area: Vaalwater

Hendrik Van Heerden

R





Lot	M	F	T
Total	1	0	1

ADDITIONAL INFORMATION:

Lot Insurance: No
 Availability: In the Ring
 Delivery Date: Subject to payment
 Free Kilometers included in bidding price: 0
 Info 01:BUSH TOILET WITH BAG

Area: Vaalwater

Hendrik Van Heerden

R





Lot	M	F	T
Total	1	0	1

ADDITIONAL INFORMATION:

Lot Insurance: No
 Availability: In the Ring
 Delivery Date: Subject to payment
 Free Kilometers included in bidding price: 0
 Info 01:SHOWER FLOOR MATS

Area: Vaalwater

Hendrik Van Heerden

R





Lot	M	F	T
Total	1	0	1

ADDITIONAL INFORMATION:

Lot Insurance: No
 Availability: In the Ring
 Delivery Date: Subject to payment
 Free Kilometers included in bidding price: 0
 Info 01:FOLDABLE CAMP DUSTBIN WITH
 Info 02:BAG

Area: Vaalwater

Hendrik Van Heerden

R





Lot	M	F	T
Total	1	0	1

ADDITIONAL INFORMATION:

Lot Insurance: No
 Availability: In the Ring
 Delivery Date: Subject to payment
 Free Kilometers included in bidding price: 0
 Info 01:FOLDABLE CAMPING DUSTBIN
 Info 02:WITH BAG

Area: Vaalwater

Hendrik Van Heerden

R





Lot	M	F	T
Total	1	0	1

ADDITIONAL INFORMATION:

Lot Insurance: No
 Availability: In the Ring
 Delivery Date: Subject to payment
 Free Kilometers included in bidding price: 0
 Info 01:1 x FRONT RUNNER STEPS &
 Info 02:BAND & 1 x FRONT RUNNER
 Info 03:SHOWER HANGER

Area: Vaalwater

Hendrik Van Heerden

R

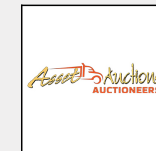



Lot	M	F	T
Total	1	0	1

ADDITIONAL INFORMATION:

Lot Insurance: No
 Availability: In the Ring
 Delivery Date: Subject to payment
 Free Kilometers included in bidding price: 0
 Info 01:DOUBLE DOOR GAS STOVE &
 Info 02:OVEN

Area: Vaalwater

Thupa Seegers

R

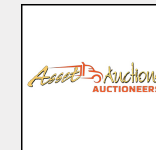



Lot	M	F	T
Total	1	0	1

ADDITIONAL INFORMATION:

Lot Insurance: No
 Availability: In the Ring
 Delivery Date: Subject to payment
 Free Kilometers included in bidding price: 0
 Info 01:ICE MACHINE - NOT TESTED
 Info 02:REQUIRES A SERVICE & GAS

Area: Vaalwater

Thupa Seegers

R

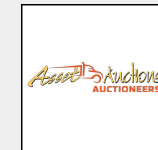



Lot	M	F	T
Total	1	0	1

ADDITIONAL INFORMATION:

Lot Insurance: No

Availability: In the Ring

Delivery Date: Subject to payment

Free Kilometers included in bidding price: 0

Info 01:2 x LARGE STAINLESS STEEL

Info 02:BASINS

Area: Vaalwater

Thupa Seegers

R

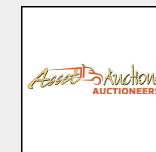



Lot	M	F	T
Total	1	0	1

ADDITIONAL INFORMATION:

Lot Insurance: No
 Availability: In the Ring
 Delivery Date: Subject to payment
 Free Kilometers included in bidding price: 0
 Info 01:2 x MEDUIM STAINLESS STEEL
 Info 02:BASINS

Area: Vaalwater

Thupa Seegers

R

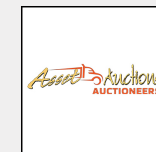



Lot	M	F	T
Total	1	0	1

ADDITIONAL INFORMATION:

Lot Insurance: No

Availability: In the Ring

Delivery Date: Subject to payment

Free Kilometers included in bidding price: 0

Info 01:3 x STAINLESS STEEL BASINS

Area: Vaalwater

Thupa Seegers

R

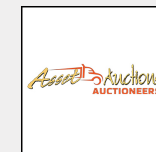



Lot	M	F	T
Total	1	0	1

ADDITIONAL INFORMATION:

Lot Insurance: No

Availability: In the Ring

Delivery Date: Subject to payment

Free Kilometers included in bidding price: 0

Info 01:ELECTRICAL MEAT BANDSAW

Info 02:WORKING CONDITION

Area: Vaalwater

Thupa Seegers

R

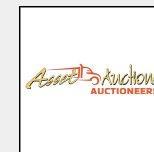



Lot	M	F	T
Total	1	0	1

ADDITIONAL INFORMATION:

Lot Insurance: No
 Availability: In the Ring
 Delivery Date: Subject to payment
 Free Kilometers included in bidding price: 0
 Info 01:ELECTICAL MEAT BANDSAW -
 Info 02:NOT BEEN TESTED

Area: Vaalwater

Thupa Seegers

R

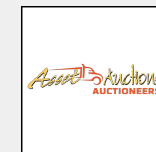



Lot	M	F	T
Total	1	0	1

ADDITIONAL INFORMATION:

Lot Insurance: No
 Availability: In the Ring
 Delivery Date: Subject to payment
 Free Kilometers included in bidding price: 0
 Info 01:ICE CRAFT FRIDGE/FREEZER
 Info 02:ELECTRICAL 220v & GAS
 Info 03:OPERATED - WORKING
 Info 04:CONDITION

Area: Vaalwater

Sarita Mostert

R





Lot	M	F	T
Total	1	0	1

ADDITIONAL INFORMATION:

Lot Insurance: No
 Availability: In the Ring
 Delivery Date: Subject to payment
 Free Kilometers included in bidding price: 0
 Info 01:SAMSUNG 8KG TOPLOADER
 Info 02:WASHING MACHINE - WORKING
 Info 03:CONDITION

Area: Vaalwater

Sarita Mostert

R

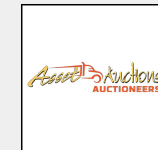



Lot	M	F	T
Total	1	0	1

ADDITIONAL INFORMATION:

Lot Insurance: No

Availability: In the Ring

Delivery Date: Subject to payment

Free Kilometers included in bidding price: 0

Info 01:ELECTRICAL FRIDGE/ FREEZER

Info 02:- NOT BEEN TESTED

Area: Vaalwater

Charlene Willemse

R

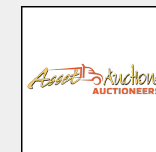



Lot	M	F	T
Total	1	0	1

ADDITIONAL INFORMATION:

Lot Insurance: No
 Availability: In the Ring
 Delivery Date: Subject to payment
 Free Kilometers included in bidding price: 0
 Info 01:FREEZER - NO GAS - NOT BEEN
 Info 02:TESTED

Area: Vaalwater

Charlene Willemse

R

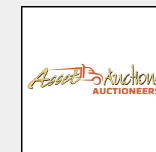



Lot	M	F	T
Total	1	0	1

ADDITIONAL INFORMATION:

Lot Insurance: No
 Availability: In the Ring
 Delivery Date: Subject to payment
 Free Kilometers included in bidding price: 0
 Info 01:1100 VENT FREE S/S
 Info 02:FIREPLACE - INCOMPLETE

Area: Vaalwater

Megamaster

R

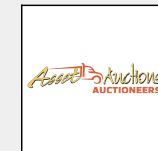



Lot	M	F	T
Total	2	0	2

ADDITIONAL INFORMATION:

Lot Insurance: No
 Availability: In the Ring
 Delivery Date: Subject to payment
 Free Kilometers included in bidding price: 0
 Info 01:260 ENAMEL ROUND PAN

Area: Vaalwater

Megamaster

R

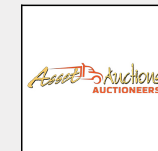



Lot	M	F	T
Total	5	0	5

ADDITIONAL INFORMATION:

Lot Insurance: No
 Availability: In the Ring
 Delivery Date: Subject to payment
 Free Kilometers included in bidding price: 0
 Info 01:CAST IRON 260 ROUND PAN

Area: Vaalwater

Megamaster

R



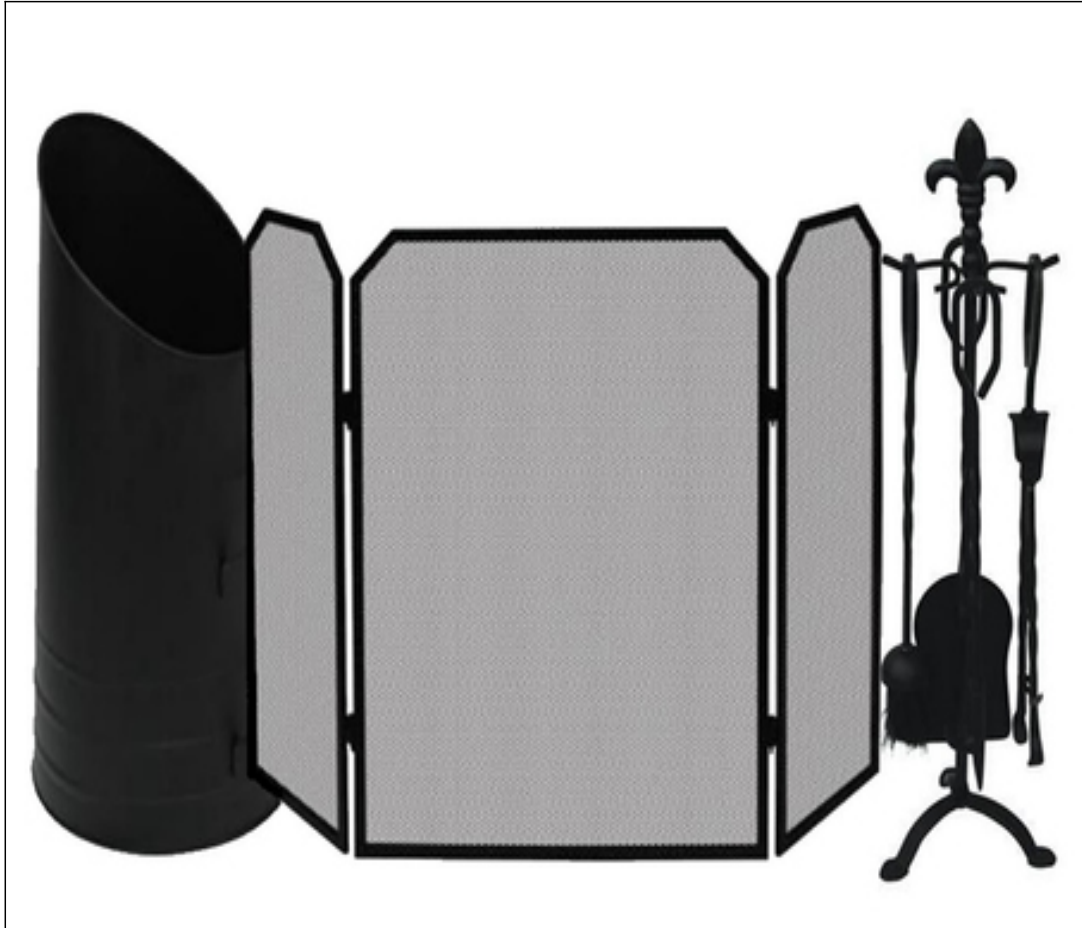

Lot	M	F	T
Total	2	0	2

ADDITIONAL INFORMATION:

Lot Insurance: No
 Availability: In the Ring
 Delivery Date: Subject to payment
 Free Kilometers included in bidding price: 0
 Info 01:3-IN-1 TOOLSET

Area: Vaalwater

Megamaster

R



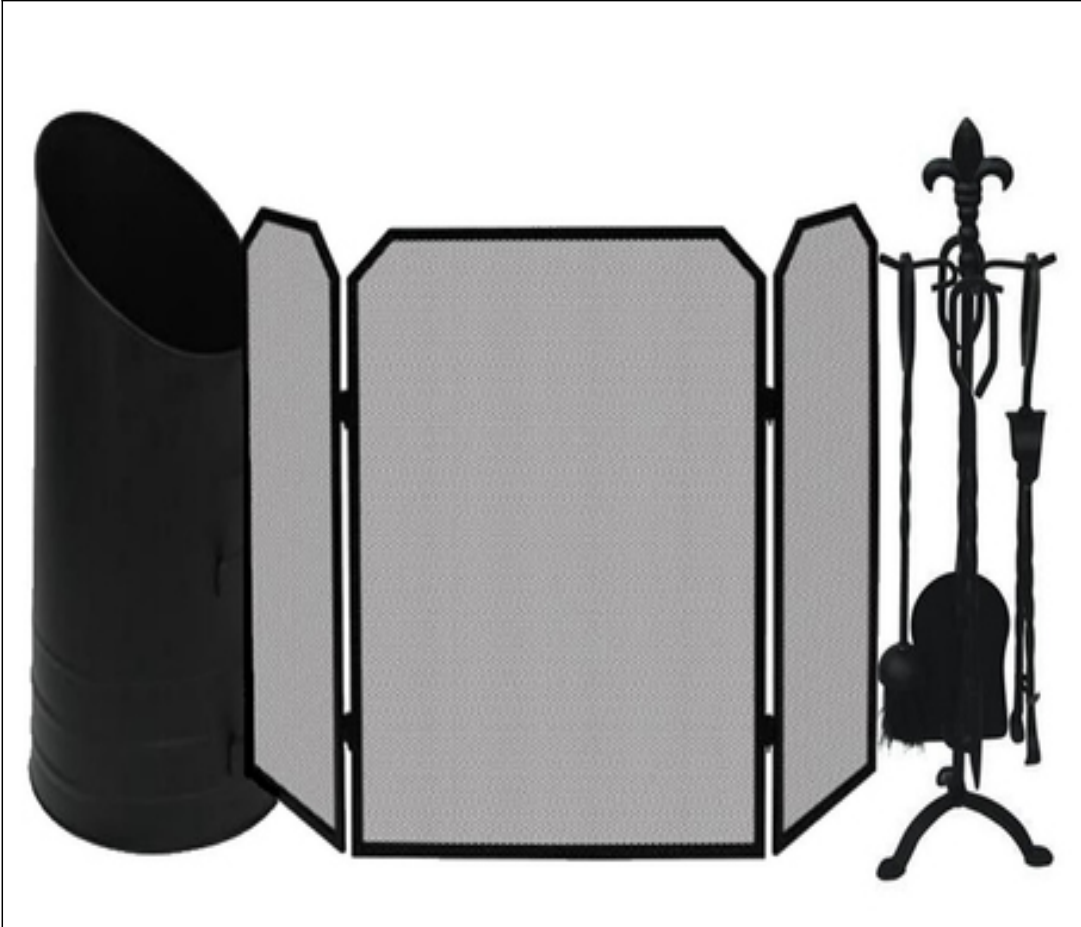

Lot	M	F	T
Total	2	0	2

ADDITIONAL INFORMATION:

Lot Insurance: No
 Availability: In the Ring
 Delivery Date: Subject to payment
 Free Kilometers included in bidding price: 0
 Info 01:3-IN-1 TOOLSET

Area: Vaalwater

Megamaster

R





Lot	M	F	T
Total	2	0	2

ADDITIONAL INFORMATION:

Lot Insurance: No
 Availability: In the Ring
 Delivery Date: Subject to payment
 Free Kilometers included in bidding price: 0
 Info 01:210 LOG BUCKET

Area: Vaalwater

Megamaster

R

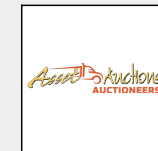



Lot	M	F	T
Total	2	0	2

ADDITIONAL INFORMATION:

Lot Insurance: No
 Availability: In the Ring
 Delivery Date: Subject to payment
 Free Kilometers included in bidding price: 0
 Info 01:500 LOG BUCKET

Area: Vaalwater

Megamaster

R





Lot	M	F	T
Total	2	0	2

ADDITIONAL INFORMATION:

Lot Insurance: No
 Availability: In the Ring
 Delivery Date: Subject to payment
 Free Kilometers included in bidding price: 0
 Info 01:500 LOG BUCKET

Area: Vaalwater

Megamaster

R





Lot	M	F	T
Total	1	0	1

ADDITIONAL INFORMATION:

Lot Insurance: No
 Availability: In the Ring
 Delivery Date: Subject to payment
 Free Kilometers included in bidding price: 0
 Info 01:570 ELITE CHARCOAL GRILL
 Info 02:COVER

Area: Vaalwater

Megamaster

R



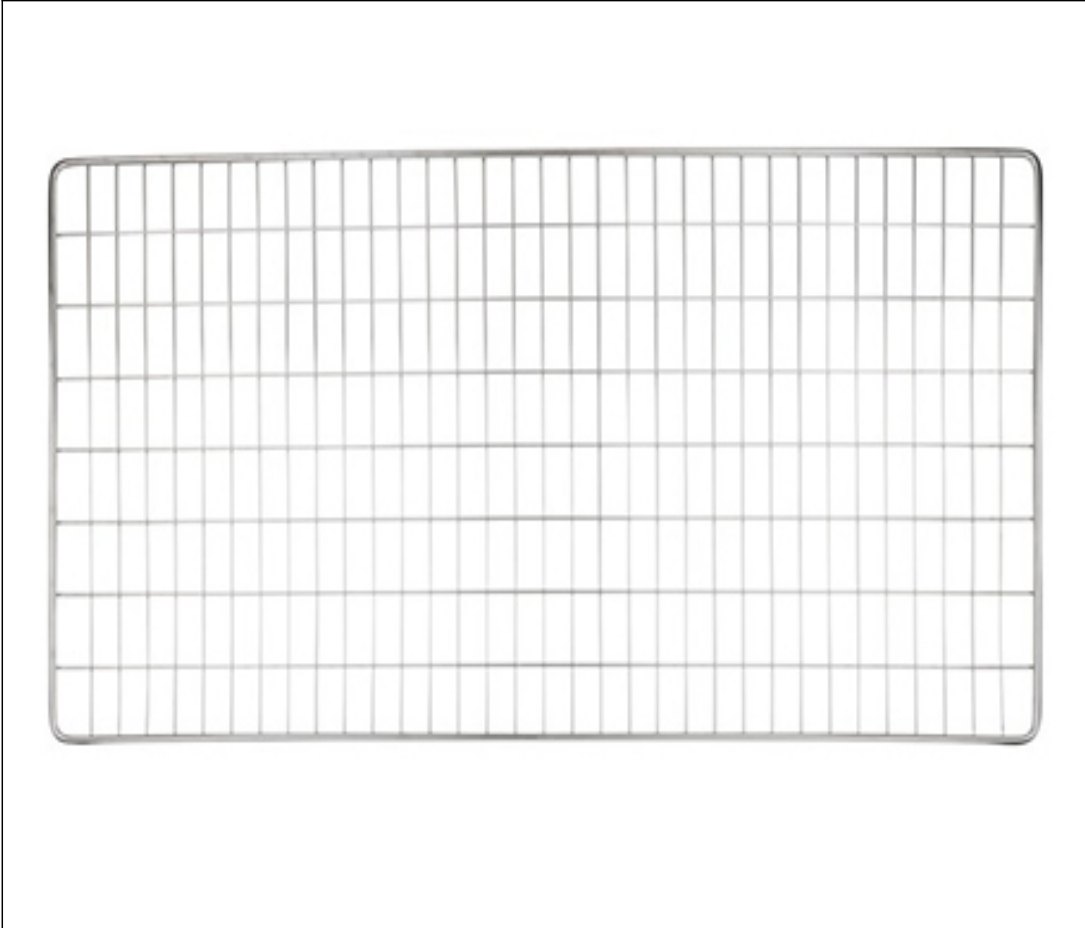

Lot	M	F	T
Total	2	0	2

ADDITIONAL INFORMATION:

Lot Insurance: No
 Availability: In the Ring
 Delivery Date: Subject to payment
 Free Kilometers included in bidding price: 0
 Info 01:725 x 500cm S/STEEL GRID

Area: Vaalwater

Megamaster

R





Lot	M	F	T
Total	1	0	1

ADDITIONAL INFORMATION:

Lot Insurance: No
 Availability: In the Ring
 Delivery Date: Subject to payment
 Free Kilometers included in bidding price: 0
 Info 01:900 CROSSOVER
 Info 02:FREESTANDING BRAAI

Area: Vaalwater

Megamaster

R





Lot	M	F	T
Total	1	0	1

ADDITIONAL INFORMATION:

Lot Insurance: No
 Availability: In the Ring
 Delivery Date: Subject to payment
 Free Kilometers included in bidding price: 0
 Info 01:900 CROSSOVER
 Info 02:FREESTANDING BRAAI

Area: Vaalwater

Megamaster

R



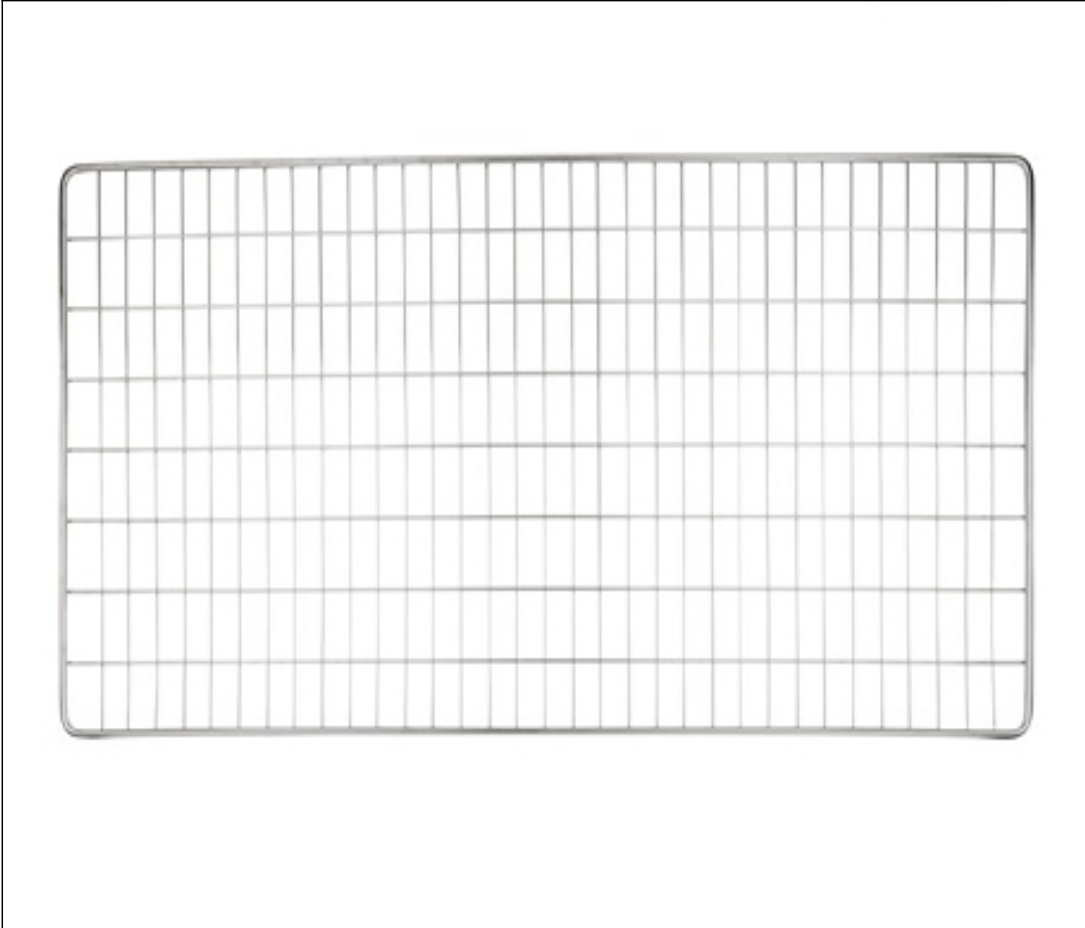

Lot	M	F	T
Total	2	0	2

ADDITIONAL INFORMATION:

Lot Insurance: No
 Availability: In the Ring
 Delivery Date: Subject to payment
 Free Kilometers included in bidding price: 0
 Info 01:900 X 500cm S/STEEL GRID

Area: Vaalwater

Megamaster

R



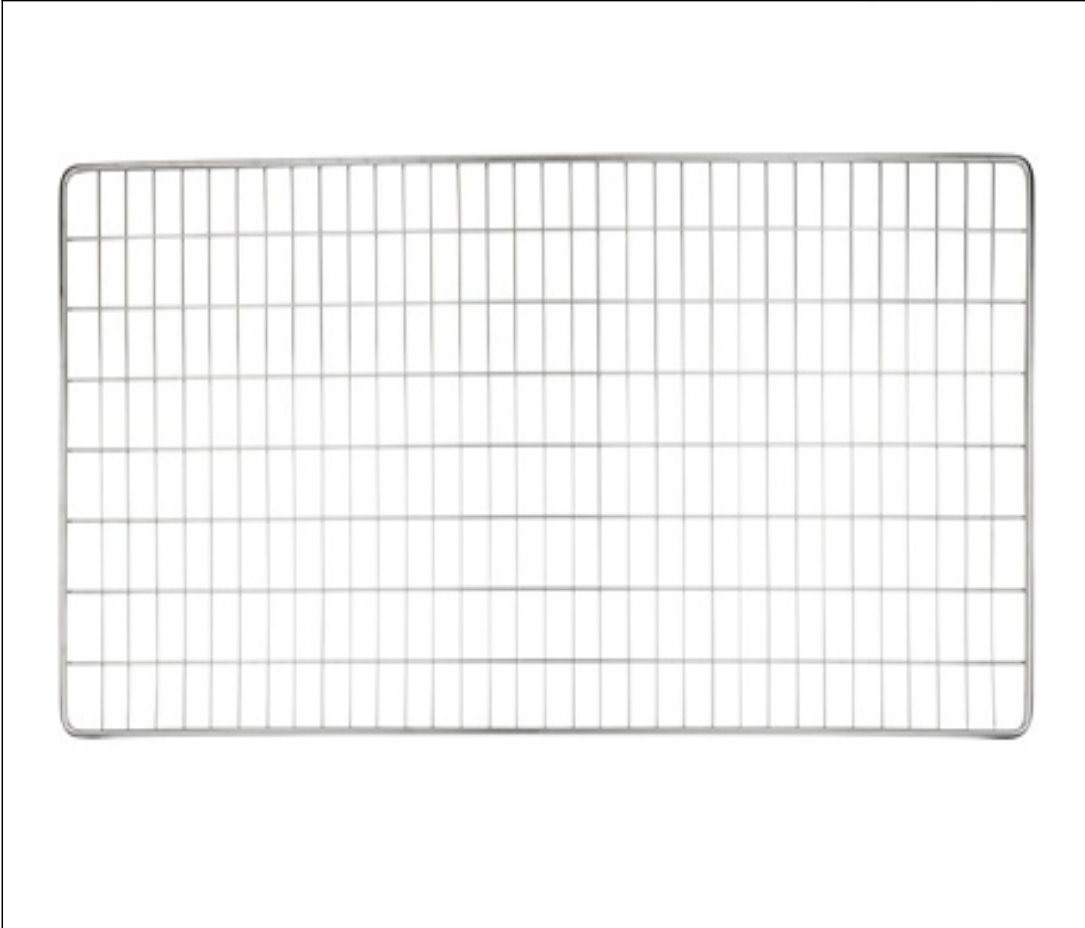

Lot	M	F	T
Total	2	0	2

ADDITIONAL INFORMATION:

Lot Insurance: No
 Availability: In the Ring
 Delivery Date: Subject to payment
 Free Kilometers included in bidding price: 0
 Info 01:900 X 500cm S/STEEL GRID

Area: Vaalwater

Megamaster

R





Lot	M	F	T
Total	2	0	2

ADDITIONAL INFORMATION:

Lot Insurance: No

Availability: In the Ring

Delivery Date: Subject to payment

Free Kilometers included in bidding price: 0

Info 01:APRON

Area: Vaalwater

Megamaster

R

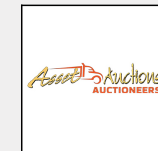



Lot	M	F	T
Total	2	0	2

ADDITIONAL INFORMATION:

Lot Insurance: No

Availability: In the Ring

Delivery Date: Subject to payment

Free Kilometers included in bidding price: 0

Info 01:BASTING BRUSH

Area: Vaalwater

Megamaster

R





Lot	M	F	T
Total	2	0	2

ADDITIONAL INFORMATION:

Lot Insurance: No
 Availability: In the Ring
 Delivery Date: Subject to payment
 Free Kilometers included in bidding price: 0
 Info 01:BASTING BRUSH

Area: Vaalwater

Megamaster

R





Lot	M	F	T
Total	1	0	1

ADDITIONAL INFORMATION:

Lot Insurance: No

Availability: In the Ring

Delivery Date: Subject to payment

Free Kilometers included in bidding price: 0

Info 01: BOSCA SPIRIT 380 S/STEEL

Info 02: FIREPLACE

Area: Vaalwater

Megamaster

R





Lot	M	F	T
Total	2	0	2

ADDITIONAL INFORMATION:

Lot Insurance: No
 Availability: In the Ring
 Delivery Date: Subject to payment
 Free Kilometers included in bidding price: 0
 Info 01:CAMPING REGULATOR

Area: Vaalwater

Megamaster

R





Lot	M	F	T
Total	2	0	2

ADDITIONAL INFORMATION:

Lot Insurance: No
 Availability: In the Ring
 Delivery Date: Subject to payment
 Free Kilometers included in bidding price: 0
 Info 01:COALSMITH CHARLIE GRILL
 Info 02:SMOKER - INCOMPLETE

Area: Vaalwater

Megamaster

R





Lot	M	F	T
Total	1	0	1

ADDITIONAL INFORMATION:

Lot Insurance: No

Availability: In the Ring

Delivery Date: Subject to payment

Free Kilometers included in bidding price: 0

Info 01:CRUSADE 3 BURNER PATIO

Info 02:GAS BRAAI

Area: Vaalwater

Megamaster

R

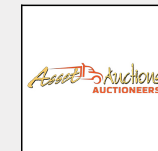



Lot	M	F	T
Total	1	0	1

ADDITIONAL INFORMATION:

Lot Insurance: No
 Availability: In the Ring
 Delivery Date: Subject to payment
 Free Kilometers included in bidding price: 0
 Info 01:CRUSADE 3 BURNER PATIO
 Info 02:GAS BRAAI

Area: Vaalwater

Megamaster

R

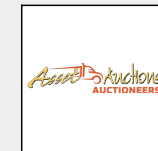



Lot	M	F	T
Total	1	0	1

ADDITIONAL INFORMATION:

Lot Insurance: No
 Availability: In the Ring
 Delivery Date: Subject to payment
 Free Kilometers included in bidding price: 0
 Info 01:CRUSADE 3 BURNER PATIO
 Info 02:GAS BRAAI

Area: Vaalwater

Megamaster

R

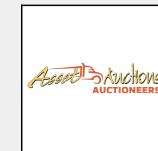



Lot	M	F	T
Total	1	0	1

ADDITIONAL INFORMATION:

Lot Insurance: No
 Availability: In the Ring
 Delivery Date: Subject to payment
 Free Kilometers included in bidding price: 0
 Info 01:CRUSADE 3 BURNER PATIO
 Info 02:GAS BRAAI

Area: Vaalwater

Megamaster

R

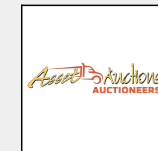



Lot	M	F	T
Total	1	0	1

ADDITIONAL INFORMATION:

Lot Insurance: No
 Availability: In the Ring
 Delivery Date: Subject to payment
 Free Kilometers included in bidding price: 0
 Info 01:CRUSADE 3 BURNER PATIO
 Info 02:GAS BRAAI

Area: Vaalwater

Megamaster

R

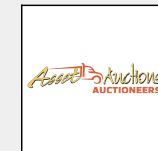



Lot	M	F	T
Total	1	0	1

ADDITIONAL INFORMATION:

Lot Insurance: No
 Availability: In the Ring
 Delivery Date: Subject to payment
 Free Kilometers included in bidding price: 0
 Info 01:CRUSADE 3 BURNER PATIO
 Info 02:GAS BRAAI

Area: Vaalwater

Megamaster

R





Lot	M	F	T
Total	1	0	1

ADDITIONAL INFORMATION:

Lot Insurance: No
 Availability: In the Ring
 Delivery Date: Subject to payment
 Free Kilometers included in bidding price: 0
 Info 01:ORIGIN 3 BURNER PATIO GAS
 Info 02:BRAAI S/STEEL

Area: Vaalwater

Megamaster

R

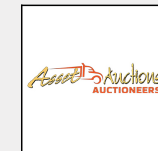



Lot	M	F	T
Total	1	0	1

ADDITIONAL INFORMATION:

Lot Insurance: No

Availability: In the Ring

Delivery Date: Subject to payment

Free Kilometers included in bidding price: 0

Info 01:ORIGIN 3 BURNER PATIO GAS

Info 02:BRAAI TEMP/REGULATOR

Area: Vaalwater

Megamaster

R

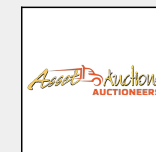



Lot	M	F	T
Total	1	0	1

ADDITIONAL INFORMATION:

Lot Insurance: No
 Availability: In the Ring
 Delivery Date: Subject to payment
 Free Kilometers included in bidding price: 0
 Info 01:MEGAMASTER GAZEBO

Area: Vaalwater

Megamaster

R





Lot	M	F	T
Total	1	0	1

ADDITIONAL INFORMATION:

Lot Insurance: No
 Availability: In the Ring
 Delivery Date: Subject to payment
 Free Kilometers included in bidding price: 0
 Info 01:MEGAMASTER GAZEBO

Area: Vaalwater

Megamaster

R





Lot	M	F	T
Total	2	0	2

ADDITIONAL INFORMATION:

Lot Insurance: No
 Availability: In the Ring
 Delivery Date: Subject to payment
 Free Kilometers included in bidding price: 0
 Info 01:LARGE GAME COOKER TOP

Area: Vaalwater

Megamaster

R





Lot	M	F	T
Total	2	0	2

ADDITIONAL INFORMATION:

Lot Insurance: No
 Availability: In the Ring
 Delivery Date: Subject to payment
 Free Kilometers included in bidding price: 0
 Info 01:GRILL FORK

Area: Vaalwater

Megamaster

R

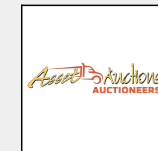

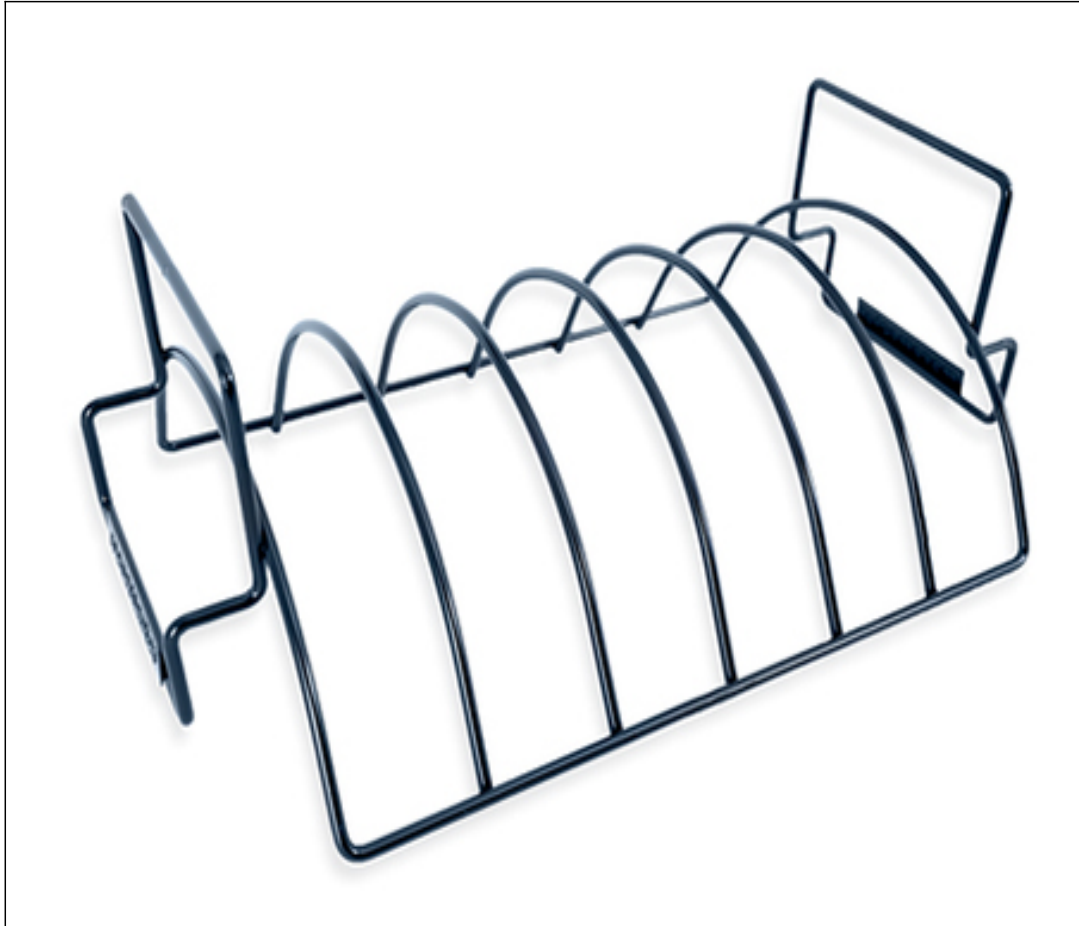

Lot	M	F	T
Total	2	0	2

ADDITIONAL INFORMATION:

Lot Insurance: No
 Availability: In the Ring
 Delivery Date: Subject to payment
 Free Kilometers included in bidding price: 0
 Info 01:GRILL RIB RACK

Area: Vaalwater

Megamaster

R



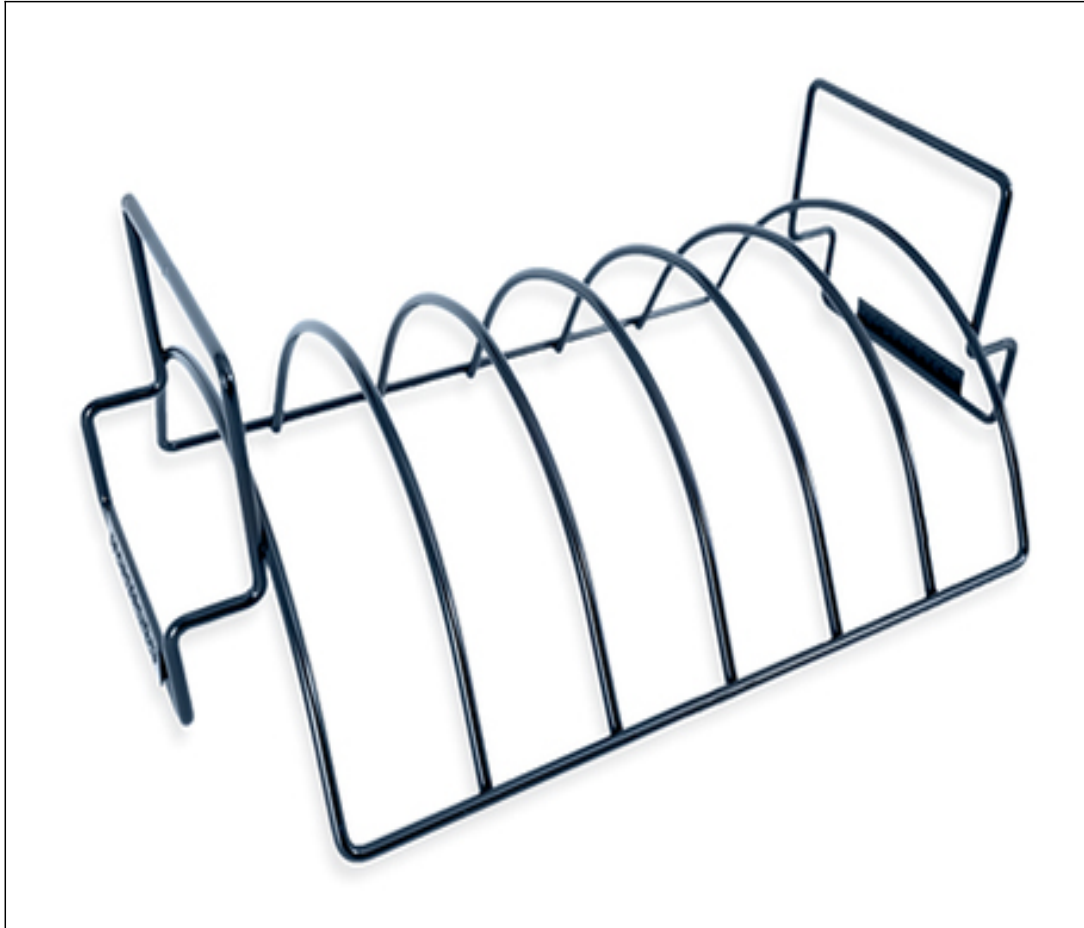

Lot	M	F	T
Total	2	0	2

ADDITIONAL INFORMATION:

Lot Insurance: No

Availability: In the Ring

Delivery Date: Subject to payment

Free Kilometers included in bidding price: 0

Info 01:GRILL RIB RACK

Area: Vaalwater

Megamaster

R



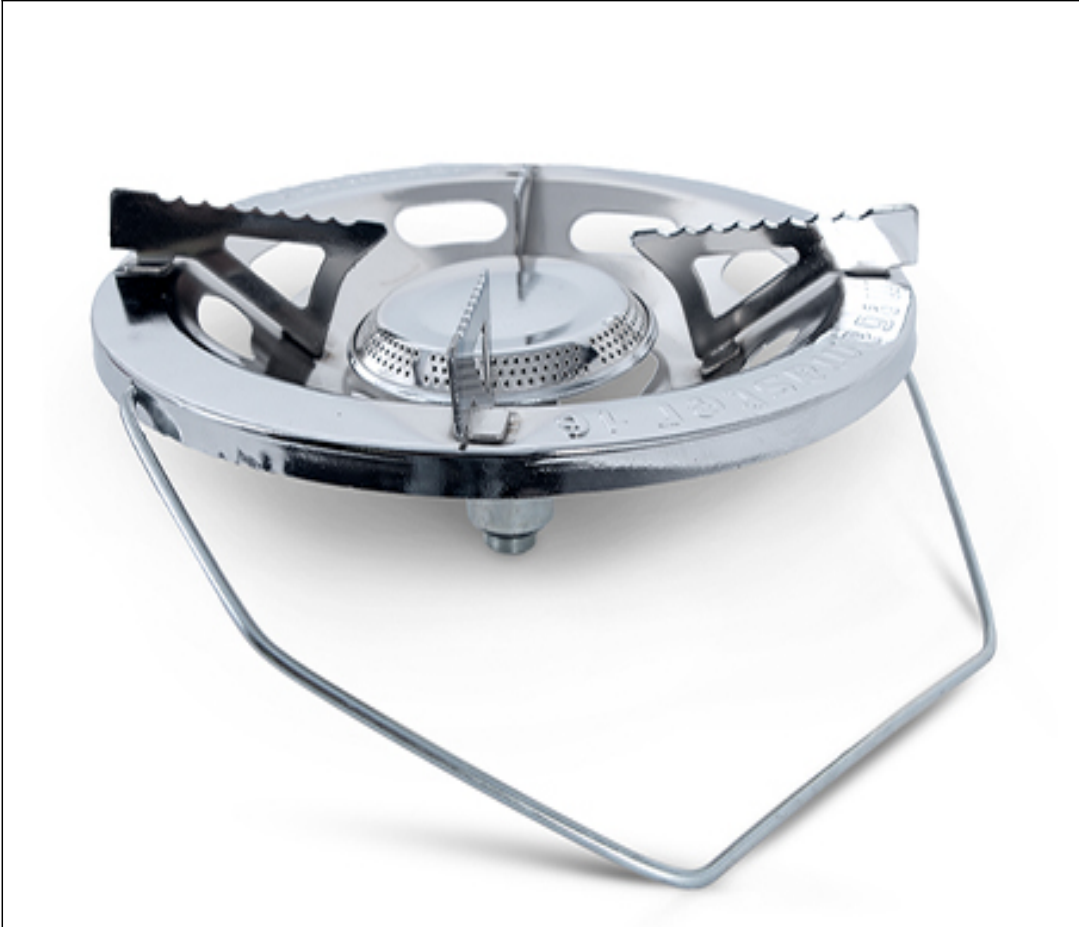

Lot	M	F	T
Total	2	0	2

ADDITIONAL INFORMATION:

Lot Insurance: No
 Availability: In the Ring
 Delivery Date: Subject to payment
 Free Kilometers included in bidding price: 0
 Info 01:LARGE COOKER TOP

Area: Vaalwater

Megamaster

R



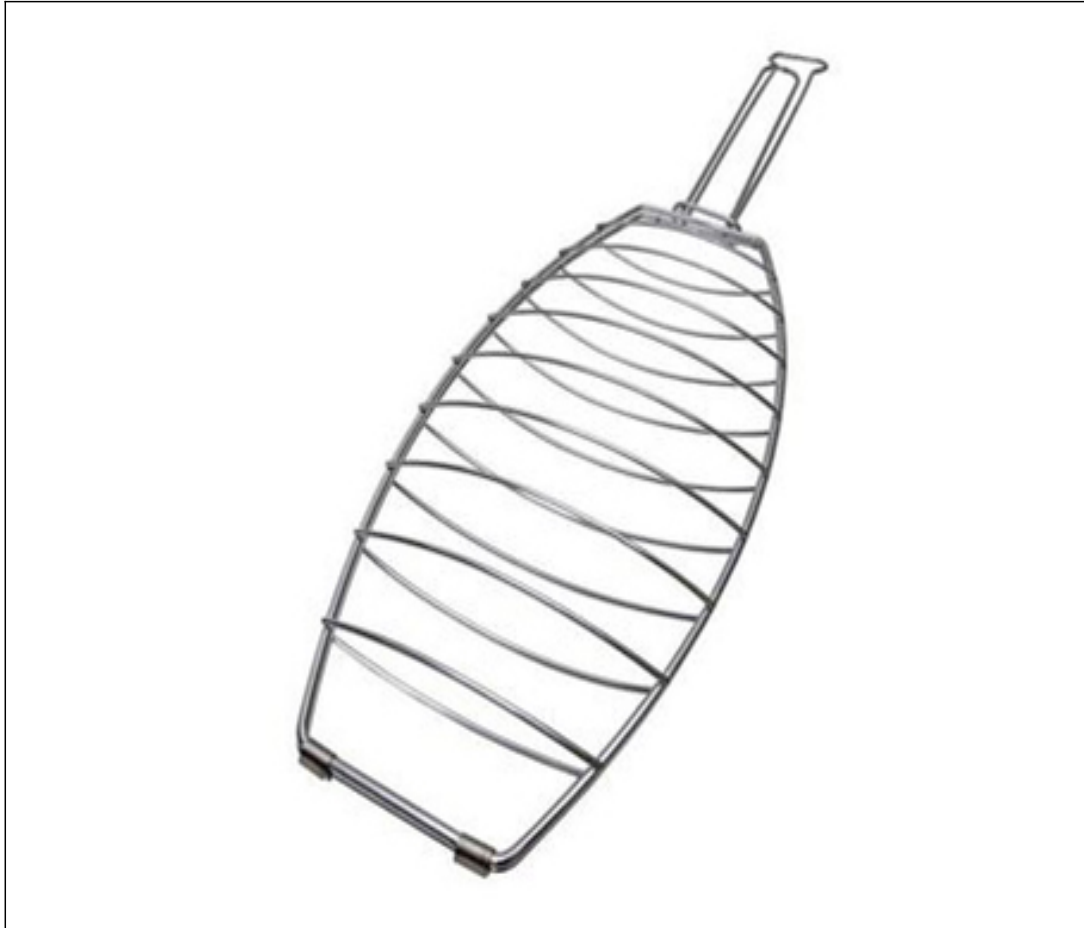

Lot	M	F	T
Total	1	0	1

ADDITIONAL INFORMATION:

Lot Insurance: No
 Availability: In the Ring
 Delivery Date: Subject to payment
 Free Kilometers included in bidding price: 0
 Info 01:LARGE FISH GRID

Area: Vaalwater

Megamaster

R





Lot	M	F	T
Total	2	0	2

ADDITIONAL INFORMATION:

Lot Insurance: No
 Availability: In the Ring
 Delivery Date: Subject to payment
 Free Kilometers included in bidding price: 0
 Info 01:LIPARI SPACE HEATER

Area: Vaalwater

Megamaster

R





Lot	M	F	T
Total	2	0	2

ADDITIONAL INFORMATION:

Lot Insurance: No
 Availability: In the Ring
 Delivery Date: Subject to payment
 Free Kilometers included in bidding price: 0
 Info 01:LIPARI SPACE HEATER

Area: Vaalwater

Megamaster

R

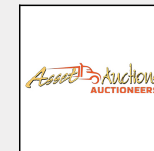

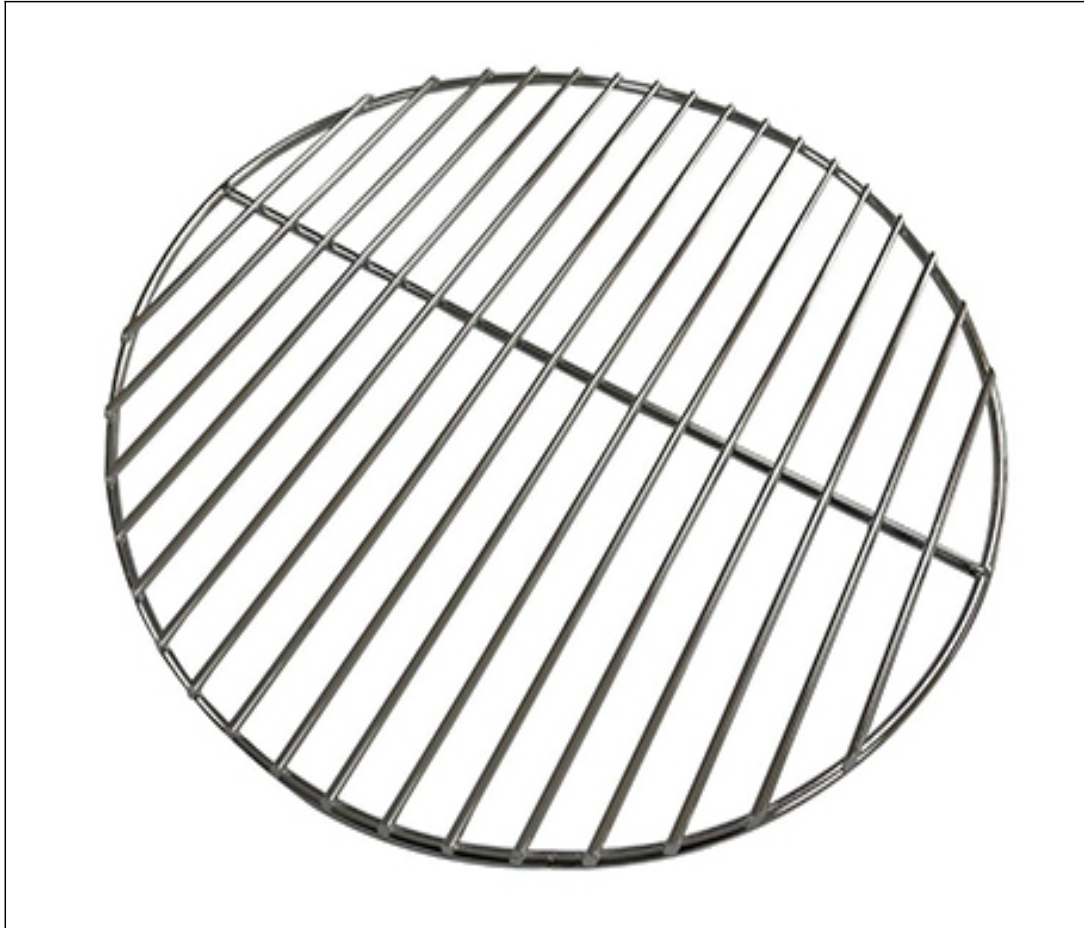

Lot	M	F	T
Total	2	0	2

ADDITIONAL INFORMATION:

Lot Insurance: No
 Availability: In the Ring
 Delivery Date: Subject to payment
 Free Kilometers included in bidding price: 0
 Info 01:M-KETTLE 47cm CHARCOAL
 Info 02:GRID

Area: Vaalwater

Megamaster

R



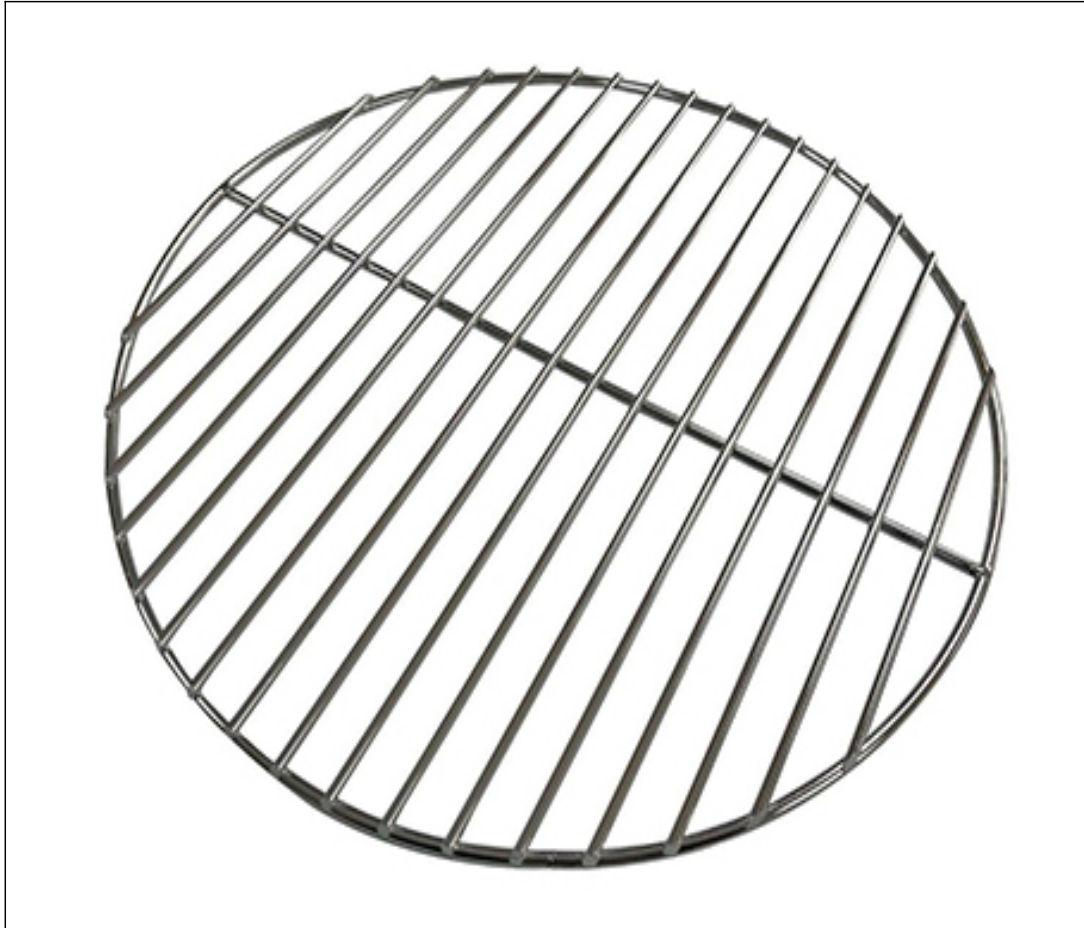

Lot	M	F	T
Total	2	0	2

ADDITIONAL INFORMATION:

Lot Insurance: No
 Availability: In the Ring
 Delivery Date: Subject to payment
 Free Kilometers included in bidding price: 0
 Info 01:M-KETTLE 47cm CHARCOAL
 Info 02:GRID

Area: Vaalwater

Megamaster

R

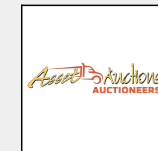



Lot	M	F	T
Total	2	0	2

ADDITIONAL INFORMATION:

Lot Insurance: No
 Availability: In the Ring
 Delivery Date: Subject to payment
 Free Kilometers included in bidding price: 0
 Info 01:M-SPA INFLATABLE CUSHION
 Info 02:SET

Area: Vaalwater

Megamaster

R

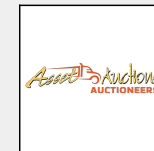



Lot	M	F	T
Total	2	0	2

ADDITIONAL INFORMATION:

Lot Insurance: No
 Availability: In the Ring
 Delivery Date: Subject to payment
 Free Kilometers included in bidding price: 0
 Info 01:NO 12 FLAT POT MEGAMASTER

Area: Vaalwater

Megamaster

R





Lot	M	F	T
Total	2	0	2

ADDITIONAL INFORMATION:

Lot Insurance: No
 Availability: In the Ring
 Delivery Date: Subject to payment
 Free Kilometers included in bidding price: 0
 Info 01:NO 3 POT MEGAMASTER

Area: Vaalwater

Megamaster

R





Lot	M	F	T
Total	1	0	1

ADDITIONAL INFORMATION:

Lot Insurance: No

Availability: In the Ring

Delivery Date: Subject to payment

Free Kilometers included in bidding price: 0

Info 01:NO 3 POT MEGAMASTER

Area: Vaalwater

Megamaster

R





Lot	M	F	T
Total	2	0	2

ADDITIONAL INFORMATION:

Lot Insurance: No
 Availability: In the Ring
 Delivery Date: Subject to payment
 Free Kilometers included in bidding price: 0
 Info 01:NON-STICK WOK SKILLET

Area: Vaalwater

Megamaster

R





Lot	M	F	T
Total	1	0	1

ADDITIONAL INFORMATION:

Lot Insurance: No
 Availability: In the Ring
 Delivery Date: Subject to payment
 Free Kilometers included in bidding price: 0
 Info 01:NOVENT BUILD-IN GAS GRATE

Area: Vaalwater

Megamaster

R





Lot	M	F	T
Total	1	0	1

ADDITIONAL INFORMATION:

Lot Insurance: No
 Availability: In the Ring
 Delivery Date: Subject to payment
 Free Kilometers included in bidding price: 0
 Info 01:NOVENT S/STEEL BUILT IN GAS
 Info 02:GRATE - INCOMPLETE

Area: Vaalwater

Megamaster

R

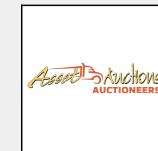



Lot	M	F	T
Total	2	0	2

ADDITIONAL INFORMATION:

Lot Insurance: No
 Availability: In the Ring
 Delivery Date: Subject to payment
 Free Kilometers included in bidding price: 0
 Info 01:PREMIUM GRILL LIGHT

Area: Vaalwater

Megamaster

R





Lot	M	F	T
Total	1	0	1

ADDITIONAL INFORMATION:

Lot Insurance: No
 Availability: In the Ring
 Delivery Date: Subject to payment
 Free Kilometers included in bidding price: 0
 Info 01:SAFARI BOMA

Area: Vaalwater

Megamaster

R





Lot	M	F	T
Total	1	0	1

ADDITIONAL INFORMATION:

Lot Insurance: No
 Availability: In the Ring
 Delivery Date: Subject to payment
 Free Kilometers included in bidding price: 0
 Info 01:SIZZLER 320 PATIO GAS BRAAI

Area: Vaalwater

Megamaster

R





Lot	M	F	T
Total	1	0	1

ADDITIONAL INFORMATION:

Lot Insurance: No
 Availability: In the Ring
 Delivery Date: Subject to payment
 Free Kilometers included in bidding price: 0
 Info 01:SIZZLER 320 PATIO GAS BRAAI

Area: Vaalwater

Megamaster

R

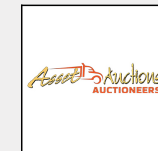



Lot	M	F	T
Total	1	0	1

ADDITIONAL INFORMATION:

Lot Insurance: No
 Availability: In the Ring
 Delivery Date: Subject to payment
 Free Kilometers included in bidding price: 0
 Info 01:SIZZLER 320 PATIO GAS BRAAI

Area: Vaalwater

Megamaster

R





Lot	M	F	T
Total	1	0	1

ADDITIONAL INFORMATION:

Lot Insurance: No
 Availability: In the Ring
 Delivery Date: Subject to payment
 Free Kilometers included in bidding price: 0
 Info 01:STANDARD TOOLSET

Area: Vaalwater

Megamaster

R





Lot	M	F	T
Total	3	0	3

ADDITIONAL INFORMATION:

Lot Insurance: No
 Availability: In the Ring
 Delivery Date: Subject to payment
 Free Kilometers included in bidding price: 0
 Info 01:TL S/STEEL TONG

Area: Vaalwater

Megamaster

R





Lot	M	F	T
Total	3	0	3

ADDITIONAL INFORMATION:

Lot Insurance: No
 Availability: In the Ring
 Delivery Date: Subject to payment
 Free Kilometers included in bidding price: 0
 Info 01:MEGAMASTER PREP TROLLEY

Area: Vaalwater

Megamaster

R





Lot	M	F	T
Total	2	0	2

ADDITIONAL INFORMATION:

Lot Insurance: No
 Availability: In the Ring
 Delivery Date: Subject to payment
 Free Kilometers included in bidding price: 0
 Info 01:MEGAMASTER PREP TROLLEY

Area: Vaalwater

Megamaster

R





Lot	M	F	T
Total	1	0	1

ADDITIONAL INFORMATION:

Lot Insurance: No
 Availability: In the Ring
 Delivery Date: Subject to payment
 Free Kilometers included in bidding price: 0
 Info 01:TUSCAN FIRESCREEN

Area: Vaalwater

Megamaster

R

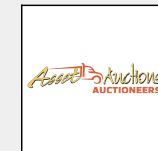

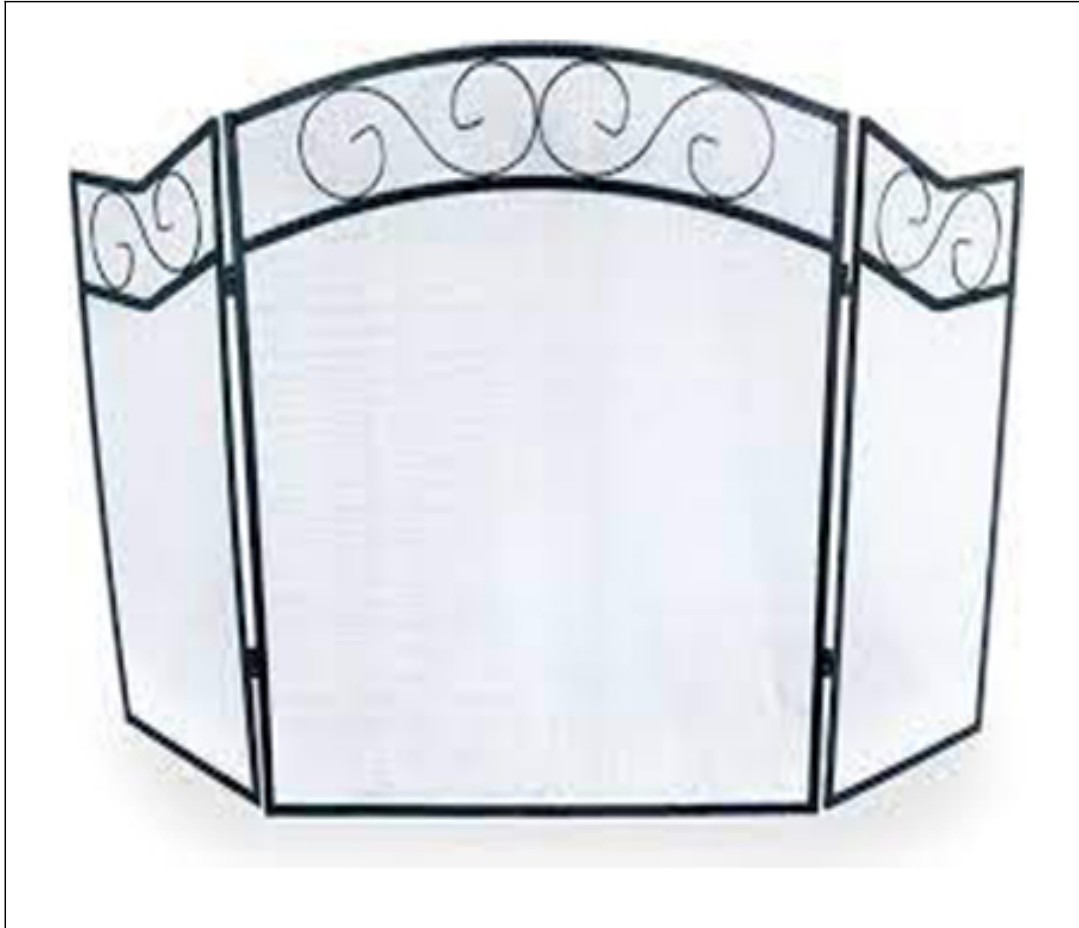

Lot	M	F	T
Total	1	0	1

ADDITIONAL INFORMATION:

Lot Insurance: No
 Availability: In the Ring
 Delivery Date: Subject to payment
 Free Kilometers included in bidding price: 0
 Info 01:VENETO FIRESCREEN

Area: Vaalwater

Megamaster

R





Lot	M	F	T
Total	2	0	2

ADDITIONAL INFORMATION:

Lot Insurance: No
 Availability: In the Ring
 Delivery Date: Subject to payment
 Free Kilometers included in bidding price: 0
 Info 01: JUNIOR GLOVE

Area: Vaalwater

Megamaster

R





Lot	M	F	T
Total	2	0	2

ADDITIONAL INFORMATION:

Lot Insurance: No
 Availability: In the Ring
 Delivery Date: Subject to payment
 Free Kilometers included in bidding price: 0
 Info 01:ACACIA BOMA

Area: Vaalwater

Megamaster

R





Lot	M	F	T
Total	2	0	2

ADDITIONAL INFORMATION:

Lot Insurance: No
 Availability: In the Ring
 Delivery Date: Subject to payment
 Free Kilometers included in bidding price: 0
 Info 01:ACACIA BOMA

Area: Vaalwater

Megamaster

R





Lot	M	F	T
Total	2	0	2

ADDITIONAL INFORMATION:

Lot Insurance: No

Availability: In the Ring

Delivery Date: Subject to payment

Free Kilometers included in bidding price: 0

Info 01:MEAT PRESS

Area: Vaalwater

Megamaster

R





Lot	M	F	T
Total	2	0	2

ADDITIONAL INFORMATION:

Lot Insurance: No
 Availability: In the Ring
 Delivery Date: Subject to payment
 Free Kilometers included in bidding price: 0
 Info 01:WIDE GRIP BRAAI TONG

Area: Vaalwater

Megamaster

R





Lot	M	F	T
Total	2	0	2

ADDITIONAL INFORMATION:

Lot Insurance: No
 Availability: In the Ring
 Delivery Date: Subject to payment
 Free Kilometers included in bidding price: 0
 Info 01:STAINLESS STEEL CLEANER

Area: Vaalwater

Megamaster

R





Lot	M	F	T
Total	1	0	1

ADDITIONAL INFORMATION:

Lot Insurance: No

Availability: In the Ring

Delivery Date: Subject to payment

Free Kilometers included in bidding price: 0

Info 01:850 CONVECTION BUILT-IN

Info 02:F/PLACE

Area: Vaalwater

Megamaster

R





Lot	M	F	T
Total	1	0	1

ADDITIONAL INFORMATION:

Lot Insurance: No
 Availability: In the Ring
 Delivery Date: Subject to payment
 Free Kilometers included in bidding price: 0
 Info 01:900 CROSSOVER S/STEEL
 Info 02:FREESTANDING BRAAI

Area: Vaalwater

Megamaster

R

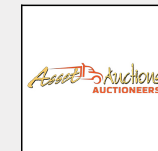



Lot	M	F	T
Total	1	0	1

ADDITIONAL INFORMATION:

Lot Insurance: No
 Availability: In the Ring
 Delivery Date: Subject to payment
 Free Kilometers included in bidding price: 0
 Info 01:900 CROSSOVER S/STEEL
 Info 02:FREESTANDING BRAAI

Area: Vaalwater

Megamaster

R

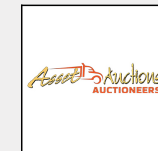



Lot	M	F	T
Total	1	0	1

ADDITIONAL INFORMATION:

Lot Insurance: No
 Availability: In the Ring
 Delivery Date: Subject to payment
 Free Kilometers included in bidding price: 0
 Info 01:700 FLATBACK FIREPLACE

Area: Vaalwater

Megamaster

R





Lot	M	F	T
Total	1	0	1

ADDITIONAL INFORMATION:

Lot Insurance: No
 Availability: In the Ring
 Delivery Date: Subject to payment
 Free Kilometers included in bidding price: 0
 Info 01:MODENA 900 F/STANDING
 Info 02:FIREPLACE

Area: Vaalwater

Megamaster

R





Lot	M	F	T
Total	2	0	2

ADDITIONAL INFORMATION:

Lot Insurance: No
 Availability: In the Ring
 Delivery Date: Subject to payment
 Free Kilometers included in bidding price: 0
 Info 01: CEDAR BOMA

Area: Vaalwater

Megamaster

R





Lot	M	F	T
Total	2	0	2

ADDITIONAL INFORMATION:

Lot Insurance: No
 Availability: In the Ring
 Delivery Date: Subject to payment
 Free Kilometers included in bidding price: 0
 Info 01: CEDAR BOMA

Area: Vaalwater

Megamaster

R





Lot	M	F	T
Total	1	0	1

ADDITIONAL INFORMATION:

Lot Insurance: Yes
 Availability: In the Ring
 Delivery Date: Subject to payment
 Free Kilometers included in bidding price: 0
 Info 01:PORTO PATIO GAS HEATER -
 Info 02:P/C

Area: Vaalwater

Megamaster

R

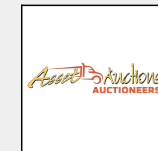



Lot	M	F	T
Total	2	0	2

ADDITIONAL INFORMATION:

Lot Insurance: No
 Availability: In the Ring
 Delivery Date: Subject to payment
 Free Kilometers included in bidding price: 0
 Info 01:STAINLESS STEEL MODERN
 Info 02:TOOLSET

Area: Vaalwater

Megamaster

R





Lot	M	F	T
Total	2	0	2

ADDITIONAL INFORMATION:

Lot Insurance: No
 Availability: In the Ring
 Delivery Date: Subject to payment
 Free Kilometers included in bidding price: 0
 Info 01:STAINLESS STEEL MODERN
 Info 02:TOOLSET

Area: Vaalwater

Megamaster

R





Lot	M	F	T
Total	2	0	2

ADDITIONAL INFORMATION:

Lot Insurance: No
 Availability: In the Ring
 Delivery Date: Subject to payment
 Free Kilometers included in bidding price: 0
 Info 01:CAST IRON 250 SQUARE
 Info 02:CHARGRILL

Area: Vaalwater

Megamaster

R





Lot	M	F	T
Total	2	0	2

ADDITIONAL INFORMATION:

Lot Insurance: No
 Availability: In the Ring
 Delivery Date: Subject to payment
 Free Kilometers included in bidding price: 0
 Info 01:CAST IRON 250 SQUARE
 Info 02:CHARGRILL

Area: Vaalwater

Megamaster

R





Lot	M	F	T
Total	2	0	2

ADDITIONAL INFORMATION:

Lot Insurance: No
 Availability: In the Ring
 Delivery Date: Subject to payment
 Free Kilometers included in bidding price: 0
 Info 01:CAST IRON 360 RECT
 Info 02:CHARGRILLER

Area: Vaalwater

Megamaster

R





Lot	M	F	T
Total	2	0	2

ADDITIONAL INFORMATION:

Lot Insurance: No
 Availability: In the Ring
 Delivery Date: Subject to payment
 Free Kilometers included in bidding price: 0
 Info 01:CAST IRON 360 RECT
 Info 02:CHARGRILLER

Area: Vaalwater

Megamaster

R





Lot	M	F	T
Total	2	0	2

ADDITIONAL INFORMATION:

Lot Insurance: No
 Availability: In the Ring
 Delivery Date: Subject to payment
 Free Kilometers included in bidding price: 0
 Info 01:ROLLING PIN

Area: Vaalwater

Megamaster

R





Lot	M	F	T
Total	2	0	2

ADDITIONAL INFORMATION:

Lot Insurance: No

Availability: In the Ring

Delivery Date: Subject to payment

Free Kilometers included in bidding price: 0

Info 01:ROLLING PIN

Area: Vaalwater

Megamaster

R





Lot	M	F	T
Total	2	0	2

ADDITIONAL INFORMATION:

Lot Insurance: No

Availability: In the Ring

Delivery Date: Subject to payment

Free Kilometers included in bidding price: 0

Info 01:JAFFEL IRON

Area: Vaalwater

Megamaster

R





Lot	M	F	T
Total	2	0	2

ADDITIONAL INFORMATION:

Lot Insurance: No

Availability: In the Ring

Delivery Date: Subject to payment

Free Kilometers included in bidding price: 0

Info 01:JAFFEL IRON

Area: Vaalwater

Megamaster

R





Lot	M	F	T
Total	1	0	1

ADDITIONAL INFORMATION:

Lot Insurance: No
 Availability: In the Ring
 Delivery Date: Subject to payment
 Free Kilometers included in bidding price: 0
 Info 01:750 SIZZLER BUILT-IN BRAAI

Area: Vaalwater

Megamaster

R





Lot	M	F	T
Total	1	0	1

ADDITIONAL INFORMATION:

Lot Insurance: No

Availability: In the Ring

Delivery Date: Subject to payment

Free Kilometers included in bidding price: 0

Info 01:750 SIZZLER BUILT-IN BRAAI

Area: Vaalwater

Megamaster

R





Lot	M	F	T
Total	1	0	1

ADDITIONAL INFORMATION:

Lot Insurance: No
 Availability: In the Ring
 Delivery Date: Subject to payment
 Free Kilometers included in bidding price: 0
 Info 01:750 SIZZLER BUILT-IN BRAAI

Area: Vaalwater

Megamaster

R





Lot	M	F	T
Total	1	0	1

ADDITIONAL INFORMATION:

Lot Insurance: No
 Availability: In the Ring
 Delivery Date: Subject to payment
 Free Kilometers included in bidding price: 0
 Info 01:1000 FIREPLACE FIRESCREEN

Area: Vaalwater

Megamaster

R





Lot	M	F	T
Total	1	0	1

ADDITIONAL INFORMATION:

Lot Insurance: No
 Availability: In the Ring
 Delivery Date: Subject to payment
 Free Kilometers included in bidding price: 0
 Info 01:1000 FIREPLACE FIRESCREEN

Area: Vaalwater

Megamaster

R





Lot	M	F	T
Total	1	0	1

ADDITIONAL INFORMATION:

Lot Insurance: No
 Availability: In the Ring
 Delivery Date: Subject to payment
 Free Kilometers included in bidding price: 0
 Info 01:VERONA FIRESCREEN

Area: Vaalwater

Megamaster

R

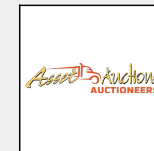



Lot	M	F	T
Total	1	0	1

ADDITIONAL INFORMATION:

Lot Insurance: No
 Availability: In the Ring
 Delivery Date: Subject to payment
 Free Kilometers included in bidding price: 0
 Info 01:VERONA FIRESCREEN

Area: Vaalwater

Megamaster

R





Lot	M	F	T
Total	1	0	1

ADDITIONAL INFORMATION:

Lot Insurance: No

Availability: In the Ring

Delivery Date: Subject to payment

Free Kilometers included in bidding price: 0

Info 01:WEBER KETTLE BRAAI

Area: Vaalwater

Megamaster

R





Lot	M	F	T
Total	1	0	1

ADDITIONAL INFORMATION:

Lot Insurance: No

Availability: In the Ring

Delivery Date: Subject to payment

Free Kilometers included in bidding price: 0

Info 01:WEBER KETTLE BRAAI

Area: Vaalwater

Megamaster

R

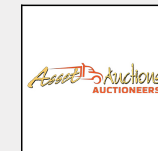



Lot	M	F	T
Total	3	0	3

ADDITIONAL INFORMATION:

Lot Insurance: No
 Availability: In the Ring
 Delivery Date: Subject to payment
 Free Kilometers included in bidding price: 0
 Info 01:WEBER KETTLE BRAAIS

Area: Vaalwater

Megamaster

R





Lot	M	F	T
Total	2	0	2

ADDITIONAL INFORMATION:

Lot Insurance: No

Availability: In the Ring

Delivery Date: Subject to payment

Free Kilometers included in bidding price: 0

Info 01: FREESTANDING BRAAIS

Area: Vaalwater

Megamaster

R

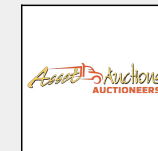



Lot	M	F	T
Total	2	0	2

ADDITIONAL INFORMATION:

Lot Insurance: No

Availability: In the Ring

Delivery Date: Subject to payment

Free Kilometers included in bidding price: 0

Info 01: FREESTANDING BRAAIS

Area: Vaalwater

Megamaster

R





Lot	M	F	T
Total	10	0	10

ADDITIONAL INFORMATION:

Lot Insurance: No

Availability: In the Ring

Delivery Date: Subject to payment

Free Kilometers included in bidding price: 0

Info 01:RED CLAY BRICK WALLPAPER

Area: Vaalwater

Orange Apple

R





Lot	M	F	T
Total	10	0	10

ADDITIONAL INFORMATION:

Lot Insurance: No

Availability: In the Ring

Delivery Date: Subject to payment

Free Kilometers included in bidding price: 0

Info 01:RED CLAY BRICK WALLPAPER

Area: Vaalwater

Orange Apple

R





Lot	M	F	T
Total	2	0	2

ADDITIONAL INFORMATION:

Lot Insurance: No
 Availability: In the Ring
 Delivery Date: Subject to payment
 Free Kilometers included in bidding price: 0
 Info 01:COTTON TASSEL THROWS
 Info 02:125cm x 150cm

Area: Vaalwater

Orange Apple

R





Lot	M	F	T
Total	2	0	2

ADDITIONAL INFORMATION:

Lot Insurance: No

Availability: In the Ring

Delivery Date: Subject to payment

Free Kilometers included in bidding price: 0

Info 01:COTTON TASSEL THROWS

Info 02:125cm x 150cm

Area: Vaalwater

Orange Apple

R





Lot	M	F	T
Total	2	0	2

ADDITIONAL INFORMATION:

Lot Insurance: No

Availability: In the Ring

Delivery Date: Subject to payment

Free Kilometers included in bidding price: 0

Info 01:COTTON TASSEL THROWS

Info 02:125cm x 150cm

Area: Vaalwater

Orange Apple

R





Lot	M	F	T
Total	6	0	6

ADDITIONAL INFORMATION:

Lot Insurance: No

Availability: In the Ring

Delivery Date: Subject to payment

Free Kilometers included in bidding price: 0

Info 01:CITRONELLA CANDLES

Area: Vaalwater

Orange Apple

R





Lot	M	F	T
Total	5	0	5

ADDITIONAL INFORMATION:

Lot Insurance: No
 Availability: In the Ring
 Delivery Date: Subject to payment
 Free Kilometers included in bidding price: 0
 Info 01:CITRONELLA CANDLES

Area: Vaalwater

Orange Apple

R





Lot	M	F	T
Total	1	0	1

ADDITIONAL INFORMATION:

Lot Insurance: No

Availability: In the Ring

Delivery Date: Subject to payment

Free Kilometers included in bidding price: 0

Info 01:KALAHARI DINING TABLE

Info 02:220 x 100 x 76cm

Area: Vaalwater

Orange Apple

R





Lot	M	F	T
Total	1	0	1

ADDITIONAL INFORMATION:

Lot Insurance: No
 Availability: In the Ring
 Delivery Date: Subject to payment
 Free Kilometers included in bidding price: 0
 Info 01:KALAHARI BENCH
 Info 02:200 x 40 x 45cm

Area: Vaalwater

Orange Apple

R





Lot	M	F	T
Total	4	0	4

ADDITIONAL INFORMATION:

Lot Insurance: No
 Availability: In the Ring
 Delivery Date: Subject to payment
 Free Kilometers included in bidding price: 0
 Info 01:GREY WASH RATTAN
 Info 02:BAR CHAIRS 62 x 52 x 105cm

Area: Vaalwater

Orange Apple

R

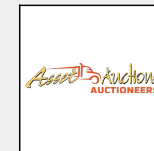



Lot	M	F	T
Total	4	0	4

ADDITIONAL INFORMATION:

Lot Insurance: No
 Availability: In the Ring
 Delivery Date: Subject to payment
 Free Kilometers included in bidding price: 0
 Info 01:GREY WASH RATTAN
 Info 02:BAR CHAIRS 62 x 52 x 105cm

Area: Vaalwater

Orange Apple

R





Lot	M	F	T
Total	3	0	3

ADDITIONAL INFORMATION:

Lot Insurance: No
 Availability: In the Ring
 Delivery Date: Subject to payment
 Free Kilometers included in bidding price: 0
 Info 01:GREY WASH RATTAN
 Info 02:BAR CHAIRS 62 x 52 x 105cm

Area: Vaalwater

Orange Apple

R

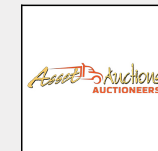



Lot	M	F	T
Total	4	0	4

ADDITIONAL INFORMATION:

Lot Insurance: No
 Availability: In the Ring
 Delivery Date: Subject to payment
 Free Kilometers included in bidding price: 0
 Info 01:NATURAL RATTAN BAR CHAIR
 Info 02:62 x 52 x 105cm

Area: Vaalwater

Orange Apple

R





Lot	M	F	T
Total	3	0	3

ADDITIONAL INFORMATION:

Lot Insurance: No

Availability: In the Ring

Delivery Date: Subject to payment

Free Kilometers included in bidding price: 0

Info 01:NATURAL RATTAN BAR CHAIR

Info 02:62 x 52 x 105cm

Area: Vaalwater

Orange Apple

R

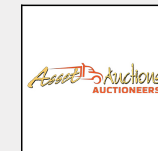



Lot	M	F	T
Total	4	0	4

ADDITIONAL INFORMATION:

Lot Insurance: No
 Availability: In the Ring
 Delivery Date: Subject to payment
 Free Kilometers included in bidding price: 0
 Info 01:WALL MOUNTABLE SHELVES
 Info 02:WITH FRAMES:
 Info 03:1 X 20 x 35 x 35cm,
 Info 04:1 X 20 x 25 x 75cm,
 Info 05:1 X 20 x 50 x 35cm,
 Info 06:1 X 20 x 65 x 35cm
 Info 07:FITTINGS LOOSE & NEEDS SCREWS

Area: Vaalwater

Orange Apple

R





Lot	M	F	T
Total	1	0	1

ADDITIONAL INFORMATION:

Lot Insurance: No
 Availability: In the Ring
 Delivery Date: Subject to payment
 Free Kilometers included in bidding price: 0
 Info 01:TABLE 179.5 x 90 x 74cm

Area: Vaalwater

Orange Apple

R





Lot	M	F	T
Total	1	0	1

ADDITIONAL INFORMATION:

Lot Insurance: No

Availability: In the Ring

Delivery Date: Subject to payment

Free Kilometers included in bidding price: 0

Info 01:WALL MOUNTABLE BATHROOM SHELF

Area: Vaalwater

Orange Apple

R

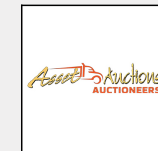



Lot	M	F	T
Total	1	0	1

ADDITIONAL INFORMATION:

Lot Insurance: No
 Availability: In the Ring
 Delivery Date: Subject to payment
 Free Kilometers included in bidding price: 0
 Info 01:SHELF 70 x 29.5 x 42cm

Area: Vaalwater

Orange Apple

R





Lot	M	F	T
Total	1	0	1

ADDITIONAL INFORMATION:

Lot Insurance: No

Availability: In the Ring

Delivery Date: Subject to payment

Free Kilometers included in bidding price: 0

Info 01:MOCHA NIGHTSTAND

Info 02:45 x 38 x 50cm

Area: Vaalwater

Orange Apple

R





Lot	M	F	T
Total	1	0	1

ADDITIONAL INFORMATION:

Lot Insurance: No
 Availability: In the Ring
 Delivery Date: Subject to payment
 Free Kilometers included in bidding price: 0
 Info 01:MOCHA DISPLAY SHELF
 Info 02:50 x 28 x 64cm

Area: Vaalwater

Orange Apple

R





Lot	M	F	T
Total	1	0	1

ADDITIONAL INFORMATION:

Lot Insurance: No
 Availability: In the Ring
 Delivery Date: Subject to payment
 Free Kilometers included in bidding price: 0
 Info 01:MOCHA CONSOLE TABLE
 Info 02:120 x 38 x 77cm

Area: Vaalwater

Orange Apple

R

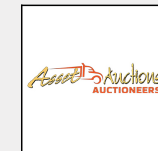



Lot	M	F	T
Total	1	0	1

ADDITIONAL INFORMATION:

Lot Insurance: No
 Availability: In the Ring
 Delivery Date: Subject to payment
 Free Kilometers included in bidding price: 0
 Info 01:SHELF ON METAL FRAME
 Info 02:70 x 36.2 x 101.5cm

Area: Vaalwater

Orange Apple

R





Lot	M	F	T
Total	1	0	1

ADDITIONAL INFORMATION:

Lot Insurance: No
 Availability: In the Ring
 Delivery Date: Subject to payment
 Free Kilometers included in bidding price: 0
 Info 01:SHELF ON METAL FRAME
 Info 02:70 x 36.2 x 101.5cm

Area: Vaalwater

Orange Apple

R





Lot	M	F	T
Total	1	0	1

ADDITIONAL INFORMATION:

Lot Insurance: No
 Availability: In the Ring
 Delivery Date: Subject to payment
 Free Kilometers included in bidding price: 0
 Info 01:CLOTHING SHELD WITH
 Info 02:BODY LENGTH MIRROR

Area: Vaalwater

Orange Apple

R





Lot	M	F	T
Total	1	0	1

ADDITIONAL INFORMATION:

Lot Insurance: No
 Availability: In the Ring
 Delivery Date: Subject to payment
 Free Kilometers included in bidding price: 0
 Info 01:RECTANGULAR MAGAZINE RACK

Area: Vaalwater

Orange Apple

R





Lot	M	F	T
Total	1	0	1

ADDITIONAL INFORMATION:

Lot Insurance: No

Availability: In the Ring

Delivery Date: Subject to payment

Free Kilometers included in bidding price: 0

Info 01:WOODEN SHELF GRAPPA

Area: Vaalwater

Orange Apple

R





Lot	M	F	T
Total	1	0	1

ADDITIONAL INFORMATION:

Lot Insurance: No
 Availability: In the Ring
 Delivery Date: Subject to payment
 Free Kilometers included in bidding price: 0
 Info 01:RATTAN SPIRAL WALL SHELF
 Info 02:60 x 20 x 25cm

Area: Vaalwater

Orange Apple

R





Lot	M	F	T
Total	1	0	1

ADDITIONAL INFORMATION:

Lot Insurance: No
 Availability: In the Ring
 Delivery Date: Subject to payment
 Free Kilometers included in bidding price: 0
 Info 01:ORGANIZER WHITE

Area: Vaalwater

Orange Apple

R





Lot	M	F	T
Total	1	0	1

ADDITIONAL INFORMATION:

Lot Insurance: No
 Availability: In the Ring
 Delivery Date: Subject to payment
 Free Kilometers included in bidding price: 0
 Info 01:NATURAL RATTAN CANE
 Info 02:3 TIER STORAGE TOWER

Area: Vaalwater

Orange Apple

R

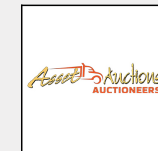



Lot	M	F	T
Total	1	0	1

ADDITIONAL INFORMATION:

Lot Insurance: No
 Availability: In the Ring
 Delivery Date: Subject to payment
 Free Kilometers included in bidding price: 0
 Info 01:NATURAL RATTAN CANE
 Info 02:3 TIER STORAGE TOWER

Area: Vaalwater

Orange Apple

R





Lot	M	F	T
Total	1	0	1

ADDITIONAL INFORMATION:

Lot Insurance: No
 Availability: In the Ring
 Delivery Date: Subject to payment
 Free Kilometers included in bidding price: 0
 Info 01:RATTAN CONSOLE TABLE

Area: Vaalwater

Orange Apple

R





Lot	M	F	T
Total	1	0	1

ADDITIONAL INFORMATION:

Lot Insurance: No

Availability: In the Ring

Delivery Date: Subject to payment

Free Kilometers included in bidding price: 0

Info 01:RATTAN ENTRANCE HOOK HANGER

Info 02:WITH SHELF 60 x 40cm

Area: Vaalwater

Orange Apple

R

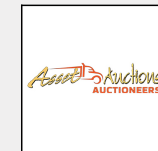



Lot	M	F	T
Total	1	0	1

ADDITIONAL INFORMATION:

Lot Insurance: No
 Availability: In the Ring
 Delivery Date: Subject to payment
 Free Kilometers included in bidding price: 0
 Info 01:RATTAN VANITY TABLE

Area: Vaalwater

Orange Apple

R





Lot	M	F	T
Total	1	0	1

ADDITIONAL INFORMATION:

Lot Insurance: No
 Availability: In the Ring
 Delivery Date: Subject to payment
 Free Kilometers included in bidding price: 0
 Info 01:RECTANGULAR RATTAN
 Info 02:TOWEL HANGE

Area: Vaalwater

Orange Apple

R





Lot	M	F	T
Total	1	0	1

ADDITIONAL INFORMATION:

Lot Insurance: No
 Availability: In the Ring
 Delivery Date: Subject to payment
 Free Kilometers included in bidding price: 0
 Info 01:TWO-TONE BLACK &
 Info 02:NATURAL BROWN RATTAN
 Info 03:2 TIER KITCHEN CART

Area: Vaalwater

Orange Apple

R





Lot	M	F	T
Total	5	0	5

ADDITIONAL INFORMATION:

Lot Insurance: No
 Availability: In the Ring
 Delivery Date: Subject to payment
 Free Kilometers included in bidding price: 0
 Info 01:BLUE & WHITE RATTAN
 Info 02:BAR CHAIRS

Area: Vaalwater

Orange Apple

R





Lot	M	F	T
Total	1	0	1

ADDITIONAL INFORMATION:

Lot Insurance: No
 Availability: In the Ring
 Delivery Date: Subject to payment
 Free Kilometers included in bidding price: 0
 Info 01:BLUE & WHITE 4 PIECE
 Info 02:RATTAN PATIO SET:
 Info 03:1 x 2 SEATER, 2 x 1 SEATER
 Info 04:WITH ROUND TABLE

Area: Vaalwater

Orange Apple

R

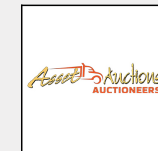



Lot	M	F	T
Total	1	0	1

ADDITIONAL INFORMATION:

Lot Insurance: No
 Availability: In the Ring
 Delivery Date: Subject to payment
 Free Kilometers included in bidding price: 0
 Info 01:WHITE CARLO RATTAN BAR CART

Area: Vaalwater

Orange Apple

R





Lot	M	F	T
Total	1	0	1

ADDITIONAL INFORMATION:

Lot Insurance: No

Availability: In the Ring

Delivery Date: Subject to payment

Free Kilometers included in bidding price: 0

Info 01:WHITE CARLO RATTAN BAR CART

Area: Vaalwater

Orange Apple

R





Lot	M	F	T
Total	1	0	1

ADDITIONAL INFORMATION:

Lot Insurance: No
 Availability: In the Ring
 Delivery Date: Subject to payment
 Free Kilometers included in bidding price: 0
 Info 01:RATTAN POLE WITH
 Info 02:CUSHION

Area: Vaalwater

Orange Apple

R

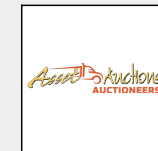



Lot	M	F	T
Total	1	0	1

ADDITIONAL INFORMATION:

Lot Insurance: No
 Availability: In the Ring
 Delivery Date: Subject to payment
 Free Kilometers included in bidding price: 0
 Info 01: RATTAN BASKET SMALL
 Info 02: WITH CUSHION

Area: Vaalwater

Orange Apple

R

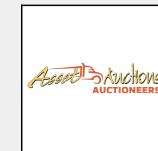



Lot	M	F	T
Total	1	0	1

ADDITIONAL INFORMATION:

Lot Insurance: No
 Availability: In the Ring
 Delivery Date: Subject to payment
 Free Kilometers included in bidding price: 0
 Info 01:RATTAN CRIB 105 x 75 x 82cm
 Info 02:WITH CUSHION

Area: Vaalwater

Orange Apple

R





Lot	M	F	T
Total	1	0	1

ADDITIONAL INFORMATION:

Lot Insurance: No
 Availability: In the Ring
 Delivery Date: Subject to payment
 Free Kilometers included in bidding price: 0
 Info 01:KUBU COFFEE TABLE

Area: Vaalwater

Orange Apple

R





Lot	M	F	T
Total	1	0	1

ADDITIONAL INFORMATION:

Lot Insurance: No
 Availability: In the Ring
 Delivery Date: Subject to payment
 Free Kilometers included in bidding price: 0
 Info 01: JUNGLE ROUND COFFEE
 Info 02: TABLE

Area: Vaalwater

Orange Apple

R





Lot	M	F	T
Total	1	0	1

ADDITIONAL INFORMATION:

Lot Insurance: No
 Availability: In the Ring
 Delivery Date: Subject to payment
 Free Kilometers included in bidding price: 0
 Info 01:OCCASIONAL GREY STEEL
 Info 02:FRAME CHAIR

Area: Vaalwater

Orange Apple

R





Lot	M	F	T
Total	1	0	1

ADDITIONAL INFORMATION:

Lot Insurance: No
 Availability: In the Ring
 Delivery Date: Subject to payment
 Free Kilometers included in bidding price: 0
 Info 01:PINK ROCKING CHAIR

Area: Vaalwater

Orange Apple

R





Lot	M	F	T
Total	1	0	1

ADDITIONAL INFORMATION:

Lot Insurance: No
 Availability: In the Ring
 Delivery Date: Subject to payment
 Free Kilometers included in bidding price: 0
 Info 01: JUNGLE WEAVED OCCASIONAL
 Info 02: CHAIR 74 x 68 x 87cm

Area: Vaalwater

Orange Apple

R





Lot	M	F	T
Total	1	0	1

ADDITIONAL INFORMATION:

Lot Insurance: No

Availability: In the Ring

Delivery Date: Subject to payment

Free Kilometers included in bidding price: 0

Info 01:OTTOMAN WITH 10cm CUSHION

Info 02:65 x 87cm

Area: Vaalwater

Orange Apple

R

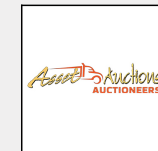



Lot	M	F	T
Total	1	0	1

ADDITIONAL INFORMATION:

Lot Insurance: No
 Availability: In the Ring
 Delivery Date: Subject to payment
 Free Kilometers included in bidding price: 0
 Info 01:DH TIGER COFFEE TABLE
 Info 02:NATURAL 80 x 50 x 35cm

Area: Vaalwater

Orange Apple

R

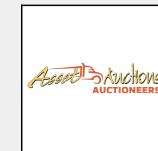



Lot	M	F	T
Total	1	0	1

ADDITIONAL INFORMATION:

Lot Insurance: No
 Availability: In the Ring
 Delivery Date: Subject to payment
 Free Kilometers included in bidding price: 0
 Info 01:DAY BED

Area: Vaalwater

Orange Apple

R





Lot	M	F	T
Total	1	0	1

ADDITIONAL INFORMATION:

Lot Insurance: No

Availability: In the Ring

Delivery Date: Subject to payment

Free Kilometers included in bidding price: 0

Info 01:SIDE TABLE OLD GOLD

Area: Vaalwater

Orange Apple

R





Lot	M	F	T
Total	1	0	1

ADDITIONAL INFORMATION:

Lot Insurance: No
 Availability: In the Ring
 Delivery Date: Subject to payment
 Free Kilometers included in bidding price: 0
 Info 01:WOODEN TABLE GRAPPA

Area: Vaalwater

Orange Apple

R





Lot	M	F	T
Total	1	0	1

ADDITIONAL INFORMATION:

Lot Insurance: No

Availability: In the Ring

Delivery Date: Subject to payment

Free Kilometers included in bidding price: 0

Info 01:NATURAL PINE SIDE TABLE WITH

Info 02:STORAGE 50 x 50 x 50cm

Area: Vaalwater

Orange Apple

R





Lot	M	F	T
Total	1	0	1

ADDITIONAL INFORMATION:

Lot Insurance: No
 Availability: In the Ring
 Delivery Date: Subject to payment
 Free Kilometers included in bidding price: 0
 Info 01:NATURAL PINE SIDE TABLE WITH
 Info 02:STORAGE L 60 x 60 x 60cm

Area: Vaalwater

Orange Apple

R





Lot	M	F	T
Total	1	0	1

ADDITIONAL INFORMATION:

Lot Insurance: No
 Availability: In the Ring
 Delivery Date: Subject to payment
 Free Kilometers included in bidding price: 0
 Info 01:RATTAN & KUBU COFFEE TABLE
 Info 02:(SMALL AREA ON TOP
 Info 03:TABLE DAMAGED)

Area: Vaalwater

Orange Apple

R





Lot	M	F	T
Total	1	0	1

ADDITIONAL INFORMATION:

Lot Insurance: No
 Availability: In the Ring
 Delivery Date: Subject to payment
 Free Kilometers included in bidding price: 0
 Info 01:BLACK & NATURAL WALL MOUNTABLE
 Info 02:SHELF

Area: Vaalwater

Orange Apple

R





Lot	M	F	T
Total	1	0	1

ADDITIONAL INFORMATION:

Lot Insurance: No
 Availability: In the Ring
 Delivery Date: Subject to payment
 Free Kilometers included in bidding price: 0
 Info 01:TRIBAL PENDANT SHADE
 Info 02:30 x 30 x 52cm

Area: Vaalwater

Orange Apple

R





Lot	M	F	T
Total	1	0	1

ADDITIONAL INFORMATION:

Lot Insurance: No
 Availability: In the Ring
 Delivery Date: Subject to payment
 Free Kilometers included in bidding price: 0
 Info 01:BLACK LAMP SHADE

Area: Vaalwater

Orange Apple

R





Lot	M	F	T
Total	1	0	1

ADDITIONAL INFORMATION:

Lot Insurance: No

Availability: In the Ring

Delivery Date: Subject to payment

Free Kilometers included in bidding price: 0

Info 01:ACACIA RECLINER CHAIR

Info 02: 72 x 60 x 115cm

Area: Vaalwater

Orange Apple

R





Lot	M	F	T
Total	1	0	1

ADDITIONAL INFORMATION:

Lot Insurance: No

Availability: In the Ring

Delivery Date: Subject to payment

Free Kilometers included in bidding price: 0

Info 01:2 PIECE GREY RATTAN PATIO SET:

Info 02:1 x 3 SEATER, 1 x 1 SEATER

Area: Vaalwater

Orange Apple

R





Lot	M	F	T
Total	1	0	1

ADDITIONAL INFORMATION:

Lot Insurance: No
 Availability: In the Ring
 Delivery Date: Subject to payment
 Free Kilometers included in bidding price: 0
 Info 01:WHITE TV STAND

Area: Vaalwater

Orange Apple

R





Lot	M	F	T
Total	1	0	1

ADDITIONAL INFORMATION:

Lot Insurance: Yes

Availability: In the Ring

Delivery Date: Subject to payment

Free Kilometers included in bidding price: 0

Info 01:HARDWOOD ROPE STOOL

Area: Vaalwater

Orange Apple

R





Lot	M	F	T
Total	1	0	1

ADDITIONAL INFORMATION:

Lot Insurance: No
 Availability: In the Ring
 Delivery Date: Subject to payment
 Free Kilometers included in bidding price: 0
 Info 01:RATTAN DISPLAY TABLE

Area: Vaalwater

Orange Apple

R





Lot	M	F	T
Total	1	0	1

ADDITIONAL INFORMATION:

Lot Insurance: No
 Availability: In the Ring
 Delivery Date: Subject to payment
 Free Kilometers included in bidding price: 0
 Info 01:RATTAN SIDE TABLE

Area: Vaalwater

Orange Apple

R





Lot	M	F	T
Total	1	0	1

ADDITIONAL INFORMATION:

Lot Insurance: No

Availability: In the Ring

Delivery Date: Subject to payment

Free Kilometers included in bidding price: 0

Info 01:SIDE TABLE L 45 x 45 x 35cm

Area: Vaalwater

Orange Apple

R





Lot	M	F	T
Total	1	0	1

ADDITIONAL INFORMATION:

Lot Insurance: No
 Availability: In the Ring
 Delivery Date: Subject to payment
 Free Kilometers included in bidding price: 0
 Info 01:BENCH L 90 x 35 x 35.5cm

Area: Vaalwater

Orange Apple

R





Lot	M	F	T
Total	1	0	1

ADDITIONAL INFORMATION:

Lot Insurance: No
 Availability: In the Ring
 Delivery Date: Subject to payment
 Free Kilometers included in bidding price: 0
 Info 01:RATTAN MAGAZINE RACK
 Info 02:50 x 35cm

Area: Vaalwater

Orange Apple

R

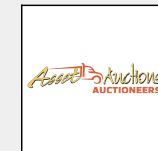



Lot	M	F	T
Total	1	0	1

ADDITIONAL INFORMATION:

Lot Insurance: No
 Availability: In the Ring
 Delivery Date: Subject to payment
 Free Kilometers included in bidding price: 0
 Info 01: RATTAN & KUBU SIDE TABLE
 Info 02:

Area: Vaalwater

Orange Apple

R





Lot	M	F	T
Total	1	0	1

ADDITIONAL INFORMATION:

Lot Insurance: No
 Availability: In the Ring
 Delivery Date: Subject to payment
 Free Kilometers included in bidding price: 0
 Info 01:3 TIER RATTAN & KUBU
 Info 02:STORAGE CART

Area: Vaalwater

Orange Apple

R





Lot	M	F	T
Total	1	0	1

ADDITIONAL INFORMATION:

Lot Insurance: No
 Availability: In the Ring
 Delivery Date: Subject to payment
 Free Kilometers included in bidding price: 0
 Info 01:WOOD CLOTHING HANGER

Area: Vaalwater

Chere Du Toit

R





Lot	M	F	T
Total	1	0	1

ADDITIONAL INFORMATION:

Lot Insurance: No

Availability: In the Ring

Delivery Date: Subject to payment

Free Kilometers included in bidding price: 0

Info 01:5 DRAWER DRESSING TABLE

Info 02:137 x 58 x 76.5cm

Area: Vaalwater

Chere Du Toit

R

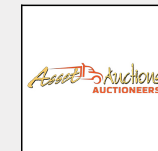



Lot	M	F	T
Total	1	0	1

ADDITIONAL INFORMATION:

Lot Insurance: No
 Availability: In the Ring
 Delivery Date: Subject to payment
 Free Kilometers included in bidding price: 0
 Info 01:WOOD OLD POST OFFICE
 Info 02:CABINET - DAMAGED

Area: Vaalwater

Conrad F Meyer

R





Lot	M	F	T
Total	1	0	1

ADDITIONAL INFORMATION:

Lot Insurance: No
 Availability: In the Ring
 Delivery Date: Subject to payment
 Free Kilometers included in bidding price: 0
 Info 01:OFFICE DESK - NO SECOND
 Info 02:DRAWER

Area: Vaalwater

Conrad F Meyer

R





Lot	M	F	T
Total	1	0	1

ADDITIONAL INFORMATION:

Lot Insurance: No
 Availability: In the Ring
 Delivery Date: Subject to payment
 Free Kilometers included in bidding price: 0
 Info 01:2 x SINGLE BED HEADBOARD
 Info 02:& FOOT END

Area: Vaalwater

Conrad F Meyer

R

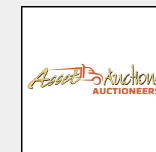



Lot	M	F	T
Total	1	0	1

ADDITIONAL INFORMATION:

Lot Insurance: No
 Availability: In the Ring
 Delivery Date: Subject to payment
 Free Kilometers included in bidding price: 0
 Info 01:GLASS SHOWER DOOR &
 Info 02:PANELS

Area: Vaalwater

Conrad F Meyer

R





Lot	M	F	T
Total	1	0	1

ADDITIONAL INFORMATION:

Lot Insurance: No

Availability: In the Ring

Delivery Date: Subject to payment

Free Kilometers included in bidding price: 0

Info 01:CAFE TABLE WITH 4 x CHAIRS

Area: Vaalwater

Conrad F Meyer

R

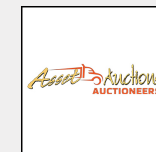



Lot	M	F	T
Total	1	0	1

ADDITIONAL INFORMATION:

Lot Insurance: No
 Availability: In the Ring
 Delivery Date: Subject to payment
 Free Kilometers included in bidding price: 0
 Info 01:CAFE TABLE WITH 3 x CHAIRS

Area: Vaalwater

Conrad F Meyer

R

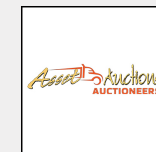



Lot	M	F	T
Total	1	0	1

ADDITIONAL INFORMATION:

Lot Insurance: No

Availability: In the Ring

Delivery Date: Subject to payment

Free Kilometers included in bidding price: 0

Info 01:1 x WOODEN TABLE, 2 X

Info 02:WOODEN SIDE TABLES - NO

Info 03:GLASS & 1 x WOODEN TABLE

Info 04:- NO GLASS

Area: Vaalwater

Conrad F Meyer

R





Lot	M	F	T
Total	1	0	1

ADDITIONAL INFORMATION:

Lot Insurance: No

Availability: In the Ring

Delivery Date: Subject to payment

Free Kilometers included in bidding price: 0

Info 01:WOODEN TABLE - OLD

Info 02:DAMAGED

Area: Vaalwater

Conrad F Meyer

R





Lot	M	F	T
Total	2	0	2

ADDITIONAL INFORMATION:

Lot Insurance: No
 Availability: In the Ring
 Delivery Date: Subject to payment
 Free Kilometers included in bidding price: 0
 Info 01:2 x WOODEN CHAIRS WITH
 Info 02:PILLOWS - DAMAGED

Area: Vaalwater

Conrad F Meyer

R

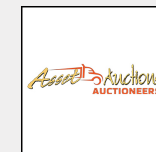



Lot	M	F	T
Total	1	0	1

ADDITIONAL INFORMATION:

Lot Insurance: No
 Availability: In the Ring
 Delivery Date: Subject to payment
 Free Kilometers included in bidding price: 0
 Info 01:DOUBLE SEATER COUCH -
 Info 02:DAMAGED

Area: Vaalwater

Conrad F Meyer

R

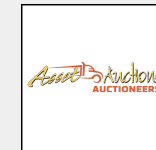



Lot	M	F	T
Total	1	0	1

ADDITIONAL INFORMATION:

Lot Insurance: No
 Availability: In the Ring
 Delivery Date: Subject to payment
 Free Kilometers included in bidding price: 0
 Info 01:WOODEN WORKSHOP /
 Info 02:GARAGE CUPBOARDS -
 Info 03:DAMAGED

Area: Vaalwater

Conrad F Meyer

R





Lot	M	F	T
Total	1	0	1

ADDITIONAL INFORMATION:

Lot Insurance: No

Availability: In the Ring

Delivery Date: Subject to payment

Free Kilometers included in bidding price: 0

Info 01:WOODEN WORKSHOP /

Info 02:GARAGE CUPBOARDS -

Info 03:DAMAGED

Area: Vaalwater

Conrad F Meyer

R





Lot	M	F	T
Total	1	0	1

ADDITIONAL INFORMATION:

Lot Insurance: No
 Availability: In the Ring
 Delivery Date: Subject to payment
 Free Kilometers included in bidding price: 0
 Info 01:WOODEN COFFEE TABLE
 Info 02:168 x 84 x 46cm - DAMAGED

Area: Vaalwater

Conrad F Meyer

R





Lot	M	F	T
Total	1	0	1

ADDITIONAL INFORMATION:

Lot Insurance: No

Availability: In the Ring

Delivery Date: Subject to payment

Free Kilometers included in bidding price: 0

Info 01:4 x SERVING TRAYS / FOLDING

Info 02:TABLES, 1 x COFFEE TABLE

Area: Vaalwater

Madelein Pienaar

R

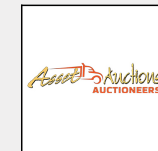



Lot	M	F	T
Total	1	0	1

ADDITIONAL INFORMATION:

Lot Insurance: No
 Availability: In the Ring
 Delivery Date: Subject to payment
 Free Kilometers included in bidding price: 0
 Info 01:WOOD ORGANIZER

Area: Vaalwater

Madelein Pienaar

R





Lot	M	F	T
Total	1	0	1

ADDITIONAL INFORMATION:

Lot Insurance: No
 Availability: In the Ring
 Delivery Date: Subject to payment
 Free Kilometers included in bidding price: 0
 Info 01:JOB LOT ASSORTED

Area: Vaalwater

Madelein Pienaar

R





Lot	M	F	T
Total	1	0	1

ADDITIONAL INFORMATION:

Lot Insurance: No
 Availability: In the Ring
 Delivery Date: Subject to payment
 Free Kilometers included in bidding price: 0
 Info 01:JOB LOT ASSORTED

Area: Vaalwater

Madelein Pienaar

R





Lot	M	F	T
Total	1	0	1

ADDITIONAL INFORMATION:

Lot Insurance: No
 Availability: In the Ring
 Delivery Date: Subject to payment
 Free Kilometers included in bidding price: 0
 Info 01: ASSORTED SCULPTURES

Area: Vaalwater

Madelein Pienaar

R





Lot	M	F	T
Total	1	0	1

ADDITIONAL INFORMATION:

Lot Insurance: No
 Availability: In the Ring
 Delivery Date: Subject to payment
 Free Kilometers included in bidding price: 0
 Info 01:JOB LOT BASKETS

Area: Vaalwater

Madelein Pienaar

R





Lot	M	F	T
Total	1	0	1

ADDITIONAL INFORMATION:

Lot Insurance: No
 Availability: In the Ring
 Delivery Date: Subject to payment
 Free Kilometers included in bidding price: 0
 Info 01: ASSORTED CRAFTS

Area: Vaalwater

Madelein Pienaar

R

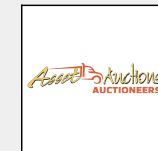



Lot	M	F	T
Total	1	0	1

ADDITIONAL INFORMATION:

Lot Insurance: No

Availability: In the Ring

Delivery Date: Subject to payment

Free Kilometers included in bidding price: 0

Info 01:JOB LOT - NR 2 & NR 3 POT

Area: Vaalwater

Madelein Pienaar

R





Lot	M	F	T
Total	7	0	7

ADDITIONAL INFORMATION:

Lot Insurance: No
 Availability: In the Ring
 Delivery Date: Subject to payment
 Free Kilometers included in bidding price: 0
 Info 01:BROOMS

Area: Vaalwater

Madelein Pienaar

R





END OF AUCTION

Thank you for your Support

Lot	M	F	T
Total	1	0	1

ADDITIONAL INFORMATION:

Lot Insurance: No

Availability: In the Ring

Delivery Date: Subject to payment

Free Kilometers included in bidding price: 0

Area: Vaalwater

African Wildlife Auctions

R

